



INDUSTRIAL ERGONOMICS®
PO BOX 518 LAKEVILLE, MN 55044-0518
(952) 933-7187 FAX (952) 997-6706
E-MAIL: Sales@Industrial-Ergonomics.com
www.Industrial-Ergonomics.com

WORKBENCH SOLUTIONS

Complete Storage & Workspace Solutions





ABOUT LISTA®

Lista provides today's most complete selection of workbenches, cabinets, workspace furniture, accessories, and more. We help you create work environments that:

- Improve productivity
- Benefit the user through smart ergonomic design
- Offer unmatched flexibility
- Are attractive and comfortable

The result of high-quality construction, and innovative engineering and design, Lista products are built to provide functionality, flexibility, and ease of use in the most demanding working environments.

A custom solution without a custom price, Lista offers the following consulting services:

DESIGN:

Lista's engineering and design team is ready to provide you with a detailed plan for your individual workspace, cabinet, and storage needs, free of charge.

We offer solutions that are designed for maximum efficiency and future flexibility, optimizing space and profitability.

FLOORSPACE UTILIZATION ANALYSIS:

We can prepare CAD drawings of site plans and elevations for a grouping of products, or entire room-sized solutions.

CUSTOMIZED SURVEYS AND LAYOUTS:

Lista experts will survey your current and future storage and workspace needs, and propose solutions that provide the highest density and greatest productivity.

INTEGRATION WITH ARCHITECTURAL & CONSTRUCTION PLANNING:

Rely on our experience coordinating with architectural and construction professionals at any stage of a project's development.

UNMATCHED CUSTOMER SUPPORT:

Lista has knowledgeable, helpful resellers throughout North America. No matter where you are, their guidance and support is always close at hand.

PRICE QUOTES:

We provide free estimates and price quotes for any project, regardless of size.

LISTA®

LISTA®: Table of Contents

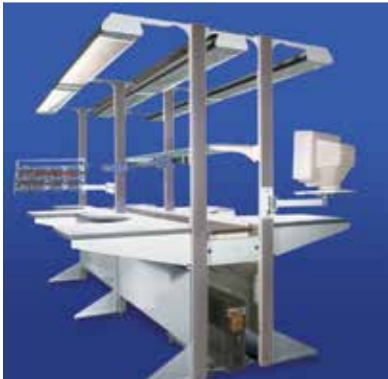

LISTA® WORKBENCH SOLUTIONS

Introduction A
 Table of Contents 1

ARLINK® WORKBENCHES

Features & Benefits 2
 Arlink 7000 Workbenches 4
 The VSI-8 System 12
 The VSI-1 System 12
 Arlink 8000 Workstation System 14
 Arlink 8000 Flow Racks 22
 Arlink 8000 Utility & Parts Carts 23
 Arlink 7000 And 8000 Universal Accessories 25

ALIGN® WORKSTATIONS

Features & Benefits 38
 Align Adjustable Height Workstations 41
 Align Workstation Worksurfaces 42
 Align Workstation Operator Adjustable Bases 44
 Align Workstation Accessories 44

ADDITIONAL PRODUCT

Mobile Cabinets 48
 Seating Solutions 52

ADDITIONAL STORAGE & WORKBENCH SOLUTIONS

Storage Wall® 54
 Stak System® 54
 Lista/Vidmar Storage Cabinets 55
 Packing & Shipping Benches 55

COLOR OPTIONS

Paint Finishes 57

INNOVATIVE WORKSPACE SOLUTIONS

Lista helps workforces work efficiently and effectively with customized workspace and storage solutions that:

- Optimize work-flow for maximum productivity
- Improve organization and accessibility, while saving space
- Support worker well-being through smart ergonomic design
- Easily adapt to changing requirements and conditions
- Stand up to the most demanding environments

Industries ranging from electronics manufacturing and light assembly to electronics test and repair to healthcare and computer repair rely on Lista for cost-effective workspace solutions that help improve operational efficiency.

Our goal is to help you create the work environment you need to be your most productive. That's why we're pleased to offer complimentary space planning assistance. Visit www.listaintl.com to request your ListaWorks™ space evaluation today.



"We love 'em! The workstations are easily adaptable, they are easy to adjust, and they can be customized with tons of options. We can easily make changes ranging from repositioning the height of the worksurface, to changing an assembly station into a packaging station."

*-Nathan Christiansen,
Connector Assembly Manager
A.E. Petsche*



ARLINK® WORKBENCHES: **FLEXIBLE. FUNCTIONAL. AFFORDABLE.**

Arlink modular workbenches and workstations provide ultimate flexibility and ergonomic support to help you work your best. Durable, easy to assemble, and highly reconfigurable, Arlink workbenches and workstations can be customized with a range of productivity-enhancing above-worksurface accessories to suit your work style and needs. Arlink products are available in stationary and mobile configurations, and can also be outfitted with complete ESD solutions for businesses requiring a static-safe environment.

Unlike some other workbenches, Arlink® 7000 All Purpose Workbenches can be tailored to your specific work requirements. With a 1,000 lb. load capacity and a selection of durable worksurfaces, Arlink 7000 All Purpose Workbenches are built to handle even the most demanding of jobs.



Completely modular, Arlink® 8000 workstations come in many configurations to suit a variety of applications. Their easy reconfigurability makes them a cost-effective solution for changing work environments.



ARLINK® 7000 WORKBENCHES

All-Purpose Arlink® 7000 workbenches are available in twelve standard sizes and two heights. Simply choose the base size, height and worksurface that best suits your needs, and add appropriate accessories. For other options and dimensions, please contact your Lista representative.

All-Purpose Arlink 7000 Workbench

- Workbench height is 30" (76 cm) or 36" (91 cm)
- Heavy-duty 2" x 2" tubular legs include leveling glides
- Load capacity for bench is 1,000 lbs. (454 kg) evenly distributed



Paint Colors

Paint and trim colors for the Arlink 8000 Modular Workstation, Arlink VSI-8 upright system, Arlink VSI-1 upright system, and the Arlink 7000 All Purpose Workbench have been expanded to include new and additional options.

Standard paint colors for both lines will continue to be Light Gray and Sand. Bright Blue and Black are being added as no upcharge options and will be available with standard lead times based on production volume at the time of order.



Light Gray (LG)



Sand (SN)



Bright Blue (BB)



Black (BL)

Worksurface Material Legend

- SL = Standard Laminate
- SD = Static Dissipative Laminate
- BB = Butcher Block-Sq Edge
- BN = Butcher Block - Bullnose Edge
- SS = Stainless Steel Over Wood Core
- RT = Phenolic Resin
- LT = Lista Top
- ST = Galvanized Steel Over Wood Core



ARLINK 7000 WORKBENCH COMBINATIONS

Stationary Workbench without Optional Leg Extenders

Bench Depth 30", Bench Height 30"

SIZE	SL	SD	BB	BN	SS	RT	LT	ST
36X30x30H	363030SL	363030SD	363030BB	363030BN	363030SS	363030RT	363030LT	363030ST
48X30x30H	483030SL	483030SD	483030BB	483030BN	483030SS	483030RT	483030LT	483030ST
60X30x30H	603030SL	603030SD	603030BB	603030BN	603030SS	603030RT	603030LT	603030ST
72X30x30H	723030SL	723030SD	723030BB	723030BN	723030SS	723030RT	723030LT	723030ST
84X30x30H	843030SL	843030SD	843030BB	843030BN	843030SS	843030RT	843030LT	843030ST
96X30x30H	963030SL	963030SD	963030BB	963030BN	963030SS	963030RT	963030LT	963030ST

Bench Depth 30", Bench Height 36"

SIZE	SL	SD	BB	BN	SS	RT	LT	ST
36X30x36H	363036SL	363036SD	363036BB	363036BN	363036SS	363036RT	363036LT	363036ST
48X30x36H	483036SL	483036SD	483036BB	483036BN	483036SS	483036RT	483036LT	483036ST
60X30x36H	603036SL	603036SD	603036BB	603036BN	603036SS	603036RT	603036LT	603036ST
72X30x36H	723036SL	723036SD	723036BB	723036BN	723036SS	723036RT	723036LT	723036ST
84X30x36H	843036SL	843036SD	843036BB	843036BN	843036SS	843036RT	843036LT	843036ST
96X30x36H	963036SL	963036SD	963036BB	963036BN	963036SS	963036RT	963036LT	963036ST

Bench Depth 36", Bench Height 30"

SIZE	SL	SD	BB	BN	SS	RT	LT	ST
36X36x30H	363630SL	363630SD	363630BB	363630BN	363630SS	363630RT	363630LT	363630ST
48X36x30H	483630SL	483630SD	483630BB	483630BN	483630SS	483630RT	483630LT	483630ST
60X36x30H	603630SL	603630SD	603630BB	603630BN	603630SS	603630RT	603630LT	603630ST
72X36x30H	723630SL	723630SD	723630BB	723630BN	723630SS	723630RT	723630LT	723630ST
84X36x30H	843630SL	843630SD	843630BB	843630BN	843630SS	843630RT	843630LT	843630ST
96X36x30H	963630SL	963630SD	963630BB	963630BN	963630SS	963630RT	963630LT	963630ST

Bench Depth 36", Bench Height 36"

SIZE	SL	SD	BB	BN	SS	RT	LT	ST
36X36x36H	363636SL	363636SD	363636BB	363636BN	363636SS	363636RT	363636LT	363636ST
48X36x36H	483636SL	483636SD	483636BB	483636BN	483636SS	483636RT	483636LT	483636ST
60X36x36H	603636SL	603636SD	603636BB	603636BN	603636SS	603636RT	603636LT	603636ST
72X36x36H	723636SL	723636SD	723636BB	723636BN	723636SS	723636RT	723636LT	723636ST
84X36x36H	843636SL	843636SD	843636BB	843636BN	843636SS	843636RT	843636LT	843636ST
96X36x36H	963636SL	963636SD	963636BB	963636BN	963636SS	963636RT	963636LT	963636ST

Actual depth of 36"D laminate worksurface is 35.25"

ARLINK 7000 WORKBENCH WORKSURFACE OPTIONS

Standard Laminate Worksurface (SL)

- Particle board core with plastic laminate top and sides and phenolic backing sheet 1 3/8" with waterfall front edge
- Standard colors are dove gray and antique white

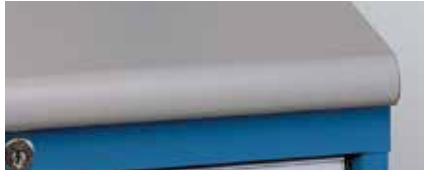

Static Dissipative Worksurface (SD)

- Particle board core with dissipative laminate top and sides and phenolic backing sheet 1 3/8" with waterfall front edge
- Grounding bolt and 10' grounding cord with 1 megohm resistor included
- Standard colors are dove gray and almond



Butcher Block Worksurface-Sq Edge (BB), Bullnose (BN)

- Satin finish 1 3/4" thick hardwood
- Available in standard square edge (1/4" radius on top front and rear edges) or bullnose front edge (full 180 degree radius)



Stainless Steel over wood core (SS)

- Worksurface is constructed of durable heavy gauge, 304 stainless steel cover, fitted over top and sides of wood core, 1 13/16" thick



Galvanized Steel over wood core (ST)

- Worksurface is constructed of durable heavy gauge galvanized steel cover, fitted over top and sides of wood core, 1 13/16" thick



Lista Top (LT)

- 3/4" thick worksurface with MDF core and 3/8" sanded, oil resistant pressed wood, top and bottom



Phenolic Resin (RT)

- Phenolic resin worksurfaces are designed for laboratory applications, are non-porous, resistant to a large number of aggressive chemicals
- Easy to clean, disinfect and maintain
- Standard phenolic tops are black (contact your representative for other colors)
- 1" thick



ARLINK 7000 ALL PURPOSE WORKBENCH

"L" Configuration

Available in multiple sizes and with 2 piece top or with 3 piece top with diagonal corner piece. Two piece tops are all square edge. Three piece tops in laminate and butcher block have front radius edge. Both may be assembled with left hand or right hand orientation.

This configuration eliminates the knee space interference of the bench leg that occurs when two independent benches are aligned in the "L" configuration.



"L" CONFIGURATION WITH 2 PIECE TOP

TOP MATERIAL	SL	SD	BB	SS	RT	LT
60X66X30X30H	60663030-2SL	60663030-2SD	60663030-2BB	60663030-2SS	60663030-2RT	60663030-2LT
60X72X30X30H	60723030-2SL	60723030-2SD	60723030-2BB	60723030-2SS	60723030-2RT	60723030-2LT
60X78X30X30H	60783030-2SL	60783030-2SD	60783030-2BB	60783030-2SS	60783030-2RT	60783030-2LT
72X66X30X30H	72663030-2SL	72663030-2SD	72663030-2BB	72663030-2SS	72663030-2RT	72663030-2LT
72X72X30X30H	72723030-2SL	72723030-2SD	72723030-2BB	72723030-2SS	72723030-2RT	72723030-2LT
72X78X30X30H	72783030-2SL	72783030-2SD	72783030-2BB	72783030-2SS	72783030-2RT	72783030-2LT
72X90X30X30H	72903030-2SL	72903030-2SD	72903030-2BB	72903030-2SS	72903030-2RT	72903030-2LT
84X66X30X30H	84663030-2SL	84663030-2SD	84663030-2BB	84663030-2SS	84663030-2RT	84663030-2LT
84X72X30X30H	84723030-2SL	84723030-2SD	84723030-2BB	84723030-2SS	84723030-2RT	84723030-2LT
84X78X30X30H	84783030-2SL	84783030-2SD	84783030-2BB	84783030-2SS	84783030-2RT	84783030-2LT
84X90X30X30H	84903030-2SL	84903030-2SD	84903030-2BB	84903030-2SS	84903030-2RT	84903030-2LT



"L" CONFIGURATION WITH 3 PIECE TOP

TOP MATERIAL	SL	SD	BB	BN	RT
60X66X30X30H	60663030-3SL	60663030-3SD	60663030-3BB	60663030-3BN	60663030-3RT
60X72X30X30H	60723030-3SL	60723030-3SD	60723030-3BB	60723030-3BN	60723030-3RT
60X78X30X30H	60783030-3SL	60783030-3SD	60783030-3BB	60783030-3BN	60783030-3RT
72X66X30X30H	72663030-3SL	72663030-3SD	72663030-3BB	72663030-3BN	72663030-3RT
72X72X30X30H	72723030-3SL	72723030-3SD	72723030-3BB	72723030-3BN	72723030-3RT
72X78X30X30H	72783030-3SL	72783030-3SD	72783030-3BB	72783030-3BN	72783030-3RT
72X90X30X30H	72903030-3SL	72903030-3SD	72903030-3BB	72903030-3BN	72903030-3RT
84X66X30X30H	84663030-3SL	84663030-3SD	84663030-3BB	84663030-3BN	84663030-3RT
84X72X30X30H	84723030-3SL	84723030-3SD	84723030-3BB	84723030-3BN	84723030-3RT
84X78X30X30H	84783030-3SL	84783030-3SD	84783030-3BB	84783030-3BN	84783030-3RT
84X90X30X30H	84903030-3SL	84903030-3SD	84903030-3BB	84903030-3BN	84903030-3RT

"L" Configuration with 3 Piece Top

ARLINK 7000 WORKBENCH CASTERS & LEG EXTENDERS

LEG EXTENDERS

Leg Extenders

- Allow nominal height adjustment of 6" on 2" increments
- Extender for 30" high workbench allows extended heights of 32", 34" or 36" overall height
- Extender for 36" high workbench allows extended heights of 38", 40" or 42" overall height
- Can not be used with caster kits



LEG EXTENDERS

LEG EXTENDERS (SET OF 4)	7Z30LE	6" ht adjustment in 2" increments
LEG EXTENDERS (SET OF 6)	7Z60LE	6" ht adjustment in 2" increments

CASTERS

Standard Casters

- Set of casters used to add mobility
- Swivel stem caster wheels are 5" x 1 1/4" and replace glides which come with stationary legs
- Increases overall nominal height by 6"
- Includes 2 swivel and 2 locking swivel casters



STANDARD CASTERS

CASTERS	7M1000	adds 6" to bench height
---------	--------	-------------------------

Leveling Casters

- Easy moving, low vibration, leveling caster
- Once in position the foot pad is lowered using the manual knob or optional ratcheting mechanism
- Lifts the wheel off the floor making the bench completely stationary



LEVELING CASTERS

LEVELING CASTERS KNOB ADJ	7M5000	3-1/4" 81.8mm
LEVELING CASTERS RATCHET ADJ	7M6000	3-1/4" 81.8mm

Lab Style Casters

- Includes 2 swivel and 2 locking swivel casters
- Soft and quiet rolling with good chemical, wear and impact resistance
- Made of natural nylon, with 30% fiberglass and double ball raceway



LAB STYLE CASTERS

LAB STYLE CASTER	7M7000	adds 6" to bench height
------------------	--------	-------------------------

Standard Casters with Mobile

Leg Extenders

- Includes 2 swivel, 2 locking swivel casters and 4 mobile leg extenders
- Allows 6" of height adjustment in 2" increments
- Lab style caster with mobile leg extenders are available by contacting your Lista representative.



STANDARD CASTERS WITH MOBILE LEG EXTENDERS

CASTERS WITH LEG EXTENDERS	7M2000	adds 6" to bench height plus addition 6" of ht adjustment in 2" increments
----------------------------	--------	--

ARLINK 7000 WORKBENCH ACCESSORIES

Under Shelf

- For extra storage space under your benches
- 12" and 18" undershelves mount to leg braces



	36	48	60	72	84	96
12"	7Z3612US	7Z4812US	7Z6012US	7Z7212US	7Z8412US	7Z9612US
18"	7Z3618US	7Z4818US	7Z6018US	7Z7218US	7Z8418US	7Z9618US

Fixed Heavy Gauge Footrest

- Channel steel footrest fastens to leg braces



	36	48	60	72	84	96
	7E36FR	7E48FR	7E60FR	7E72FR	7E84FR	7E96FR

Back And End Stops

- Steel stops fasten to worksurface to provide back and end stops
- Stops extend approx. 4" above workbench top
- End stops are 30" deep and have rounded front corners
- Back stop can also be attached to riser shelf



	36	48	60	72	84	96
BACK AND END STOPS	36ES	48BES	60BES	72BES	84BES	96BES
BACK STOP ONLY	7J36BS	7J48BS	7J60BS	7J72BS	7J84BS	7J96BS

Outlet Strip

- Surface mounts to top or bottom of worksurface
- Lighted on/off switch
- Includes 6' power cord and circuit breaker
- Painted silver finish



PART NO.	DESCRIPTION
7H48EOP	48", 8 outlets, 15 Amp

ARLINK 7000 AND 8000 WORKBENCH ABOVE- WORKSURFACE ACCESSORIES

Riser Shelf With Box Supports

- 14" (36 cm) deep shelves are finished in either standard laminate, static dissipative laminate or butcher block to match specified worksurface
- Steel box supports are 19" (48 cm) high and 11" (28 cm) deep



	36	48	60	72	84	96
STANDARD LAMINATE	361419SL	481419SL	601419SL	721419SL	841419SL	961419SL
STATIC DISSIPATIVE LAMINATE	361419SD	481419SD	601419SD	721419SD	841419SD	961419SD
BUTCHER BLOCK	361419BB	481419BB	601419BB	721419BB	841419BB	961419BB
STAINLESS STEEL	361419SS	481419SS	601419SS	721419SS	841419SS	961419SS
GALVANIZED STEEL	361419ST	481419ST	601419ST	721419ST	841419ST	961419ST
PHENOLIC RESIN	361419RT	481419RT	601419RT	721419RT	841419RT	961419RT

Electrical Panel Insert For Box Support

- The panel insert includes illuminated 15 Amp circuit breaker, 4 duplex receptacles and 7.5' power cord
- Electrical panels can be used on one or both shelf supports and can be purchased with riser shelf or added later
- CSA listed
- 20 Amp and GFCI available on request



PART NO.

7Z19EP-□

LED Undershef Light

- Anodized aluminum housing
- Polycarbonate lens & end caps
- 3 Position switch (high/low/off)
- Magnetic and swivel mounting
- CRI 85
- Color Temp 5000K
- Lumens:
 - 23" = 1200 lm
 - 34" = 1800 lm
 - 45" = 2500 lm



LED UNDERSHELF LIGHT	23"	34"	45"
	7Z23LED	7Z34LED	7Z45LED
MAGNETIC MOUNTING BRACKETS	7ZLED-M		
SWIVEL MOUNTING BRACKETS	7ZLED-S		
CORD CLIPS	7ZLED-C		



HANGING DRAWERS

Hanging Drawer

- Steel drawer mounts under worksurface, and can slide to any horizontal position
- Includes steel ball bearing slides and recessed handles
- 100% full extension
- Each unit comes with a lock and 2 keys
- Keyed-alike and master locks are available. 16 3/4" wide. Usable inside dimensions: 13 1/4" wide x 16 15/16" deep

Usable heights can be found in chart

Shallow Lap Drawer

- 21 3/8" wide x 18 3/4" deep
- Lock not available
- Steel ball bearing slides and full length integrated handle



WORKSURFACE DEPTH	30" D	36"
HANGING CABINET, SINGLE 5 3/4"H DRAWER	7L1000	7L1001
HANGING CABINET, TWO 2 3/4"H DRAWERS	7L1200	7L1201
HANGING CABINET, TWO 5 3/4"D DRAWERS	7L5000	7L5001
HANGING CABINET, FOUR 2 3/4" H DRAWERS	7L1600	7L1601
HANGING CABINET, TWO 2 3/4"D, ONE 5 3/4"H DRAWERS	7L1400	7L1401
HANGING CABINET, ONE 5 3/4"H, ONE 13 15/15"D FILE DRAWERS	7L2000	7L2001
HANGING CABINET, THREE 5 3/4"H DRAWERS	7L3000	7L3001
HANGING CABINET, TWO 2 3/4"H, ONE 13 15/15"D FILE DRAWERS	7L1800	7L1801
HANGING CABINET, TWO 2 3/4"H DRAWERS, TWO 5 3/4"D DRAWERS	7L2100	7L2101
HANGING CABINET, SINGLE 13 15/15"H FILE DRAWER,	7L1100	7L1101
SHALLOW LAP DRAWER	7L8000	7L8001

DRAWER PULL OPTIONS

Hanging Cabinet Tech Drawer Pull (Chrome Color)	4875-CHRM
Hanging Cabinet Tech Drawer Pull (Brushed Silver)	4875-BRSH
Hanging Cabinet Tech Drawer Pull (Gloss Black)	4875-GBLK

Pelican Drawer

- Secure storage for legal hanging files or personal effects, plus segmented tray for pencils, pens, paper clips, etc.
- Designed to allow easy clearance for worker's knees
- Thermo-formed polystyrene body with polyurethane drawer face
- Mounts under worksurface to worksurface support beams
- Includes concealed ball bearing slides and fully integrated locking system



WORKSURFACE DEPTH	30" D	36"
PELICAN DRAWER	7L6000	7L6001

THE VSI-8 SYSTEM

The VSI-8 System is designed to expand the efficiency of:

- Align® adjustable height workstations
- Lista technical electronic workstations
- Lista industrial workbenches
- Retrofit to existing workbenches

You can create highly productive and efficient work centers by adding above-worksurface work aids such as task lighting, storage shelves, power beams, parts bin rails, etc.

With the VSI-8 System, you're able to utilize the Arlink 8000 system's wide range of shelving and accessory options that easily attach to the vertical column without the need for tools, using the micro and macro slots on both sides of the upright columns.

The VSI-8 System is easily installed by in-house personnel and can be utilized as a single unit on a stand-alone bench, or linked together using our starter/adder system. VSI columns are double-sided, and one VSI may service two benches when benches are positioned back-to-back or mounted in the center of a single bench.



VSI-8 uprights and accessories mount onto any workbench worksurface to provide a complete accessory system. VSI-8 uprights' double-sided columns allow uprights and accessories to be shared between two benches.

NEW TRIM FEATURES & IMPROVEMENTS:

Trim profile has been changed to:

- Give the column a larger, more robust, appearance
- Increase the capacity for cord management
- Accommodate future addition of column mounted utility modules such as gas, air, power and data

Compatibility:

The new trim profile is backward compatible with all previous Arlink 8000 columns. There will be a spacing conflict with some older systems between column accessories such as privacy panels, louvered panels and pegboard panels and the variable angle shelf. New iterations of these accessories will be compatible with both old and new style trim.

Column Cap

The column cap has been redesigned to provide a more positive and secure attachment to the column. Material thickness has been increased and color will be matched to the steel paint color. The column cap is included on all columns 54" h or shorter and is optional on all other heights.

VSI-8 Column Trim Color Options

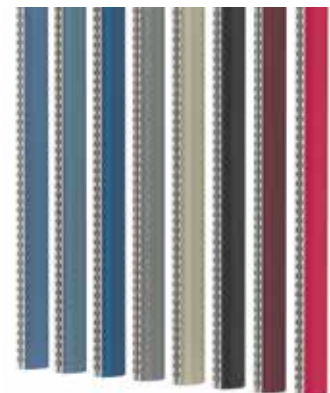

- Bright Blue (BB)
- Classic Blue (CB)
- Royal Blue (RB)
- Dark Gray (GR)
- Sand (SN)
- Black (BL)
- Burgundy (BUR)
- Red (NR)

THE VSI-1 SYSTEM

The VSI-1 System is designed to expand the efficiency of any workbench, regardless of manufacturer. Frames are sturdy, heavy gauge steel, and are slotted front and back at 1" increments for mounting accessories. Starter frames consist of 2 upright posts and a horizontal rail. Adder sets consist of an additional upright and horizontal rail. Foot plate is 2 3/4" x 4".



VSI-8

Features sturdy 45" high, 1 1/4" wide, 4" deep, roll-formed steel columns that fasten to the bench top and are stabilized by a modesty panel.

Starter assembly includes:

- 2 columns, 4 trim strips
- 1 modesty panel and mounting hardware

Adder assembly includes:

- 1 mounting column, 2 trim strips,
- 1 modesty panel and mounting hardware
- Trim strip color can be chosen from the chart on page 12
- Foot plate for surface mount uprights is 5" x 3"
- Surface mount VSI-8 System width must be a minimum of 6" shorter than worksurface width



SURFACE MOUNT	24"	30"	36"	42"	48"	60"	72"
VSI-8 STARTER ASSEMBLY (45"H)	9412-24S	9412-30S	9412-36S	9412-42S	9412-48S	9412-60S	9412-72S
ADDER ASSEMBLY (45"H)	9412-24A	9412-30A	9412-36A	9412-42A	9412-48A	9412-60A	N/A
LOW PROFILE VSI-8 UPRIGHT SYSTEM (24"H)	PAIR-4086	SINGLE-4087					

Rear Mount VSI-8 for Align Bench

Features sturdy 45" high, 1 1/4" wide, 4" deep, roll-formed steel columns that mounts to rear frame of the Align bench and is stabilized by a modesty panel.

Starter assembly includes:

- 2 columns, 4 trim strips
- 1 modesty panel and mounting hardware

Adder assembly includes:

- 1 mounting column, 2 trim strips,
- 1 modesty panel and mounting hardware
- Trim strip color can be chosen from the chart on page 12
- Includes mounting brackets for Align bench
- Rear Mount VSI-8 Systems can be full width of the Align workstation base



REAR MOUNT FOR ALIGN SECTION WIDTH*	24"	30"	36"	42"	48"	60"	72"
STARTER ASSEMBLY	9ADJ-VSI-824S	9ADJ-VSI-830S	9ADJ-VSI-836S	9ADJ-VSI-842S	9ADJ-VSI-848S	9ADJ-VSI-860S	9ADJ-VSI-872S
ADDER ASSEMBLY	9ADJ-VSI-824A	9ADJ-VSI-830A	9ADJ-VSI-836A	9ADJ-VSI-842A	9ADJ-VSI-848A	N/A	N/A

*section width must be equal to or less than Align worksurface base width

VSI-1

Frames are sturdy, heavy gauge steel, and are slotted front and back at 1" increments for mounting accessories. Uprights are available in heights of 30" and 48". Footplate is 2 3/4" x 4".

Starter assembly includes:

- 2 uprights
- 1 horizontal rail and mounting hardware

Adder assembly includes:

- 1 uprights
- 1 horizontal rail and mounting hardware



VSI-1	24"	30"	36"	42"	48"	60"
STARTER ASSEMBLY (48"H)	7Z3011	7Z3001	7Z3002	7Z3013	7Z3003	7Z3004
ADDER ASSEMBLY (48"H)	7Z3012	7Z3006	7Z3007	7Z3014	7Z3008	7Z3009
STARTER ASSEMBLY (30"H)	7Z3011C30	7Z3001C30	7Z3002C30	7Z3013C30	7Z3003C30	7Z3004C30
ADDER ASSEMBLY (30"H)	7Z3012C30	7Z3006C30	7Z3007C30	7Z3014C30	7Z3008C30	7Z3009C30

ARLINK® 8000 WORKSTATION SYSTEM

Arlink® 8000 workstations give the user the greatest flexibility possible. Our unique Definite Positioning System®, numerous footprint configurations, and easy-to-assemble starter and adder sections, mean you can easily adapt and reconfigure your workstations as your needs evolve.

Definite Positioning System®

An innovative assembly concept which features one macro and two micro slots on each side of a high strength column, this approach greatly reduces the time and effort needed to attach components to the system, while making highly efficient use of space. Since columns are double-sided, a single column may be used by two back-to-back workstations, as well as adjacent sections.

Macro slots provide support for heavy-duty components, such as worksurfaces and shelving. In the case of adjacent workstation sections, the macro slot is utilized by both to save space and reduce system cost. Components that attach to the macro slots are vertically adjustable in 3" increments.

Micro slots provide support for lighter-duty components, such as power beams and parts bin rails. Micro slots are located to the left and right of the macro slot, and provide maximum component placement options. Components that attach to the micro slots are vertically adjustable in 1" increments.

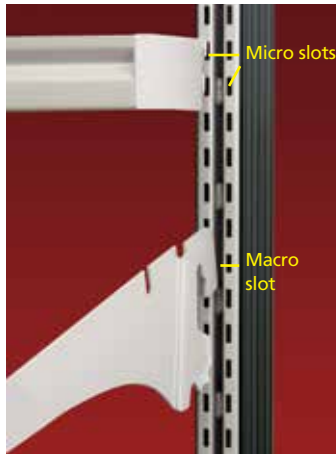

Brackets fit into either micro slots or macro slots.

Paint Colors

Paint colors for the Arlink® 8000 Modular Workstations are Light Gray and Sand. Bright Blue and Black are available with standard lead times based on production volume at time of order.

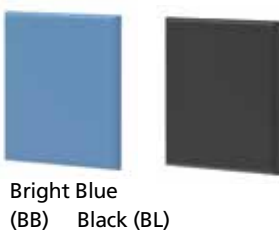

NEW TRIM FEATURES & IMPROVEMENTS:

Trim profile has been changed to:

- Give the column a larger, more robust, appearance
- To increase the capacity for cord management
- To accommodate future addition of column mounted utility modules such as gas, air, power and data

Compatibility:

- Larger trim is available in 8 trim colors and provides increased internal capacity for cord and utility management
- Backward compatible with all existing and previous Arlink® 8000 columns

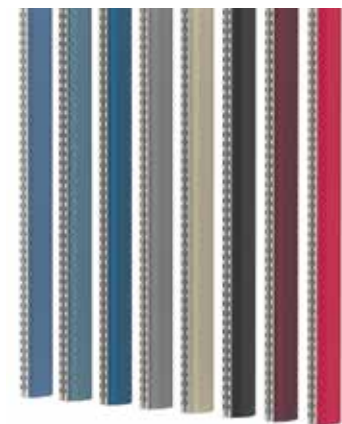

- Bright Blue (BB)
- Classic Blue (CB)
- Royal Blue (RB)
- Dark Gray (GR)
- Sand (SN)
- Black (BL)
- Burgundy (BUR)
- Red (NR)



ARLINK 8000 WORKSTATION CONFIGURATION OPTIONS

Floor space utilization

Arlink® 8000 workstations enable you to achieve maximum productivity per square foot. Our workstations can be designed in numerous configurations to meet any application. You can configure your workstations to suit your needs today, and as future needs evolve.

Many workstation configurations may also be ordered with mobile capabilities, enabling you to quickly and easily relocate entire workstation groupings.

Please contact your Lista representative for additional configuration options.

Conveyor workstations

The Arlink® 8000 family of conveyor workstation systems provides cost-effective, high-efficiency workflow management throughout your entire production stream, between automatic machines and in operations including:

- Manual assembly areas
- Inspection
- Testing
- Rework
- Packaging

Systems are available with single- or multi-level conveyor or easily integrated with the conveyor of your choice.

In-line Configuration



In-line Back-to-Back Configuration

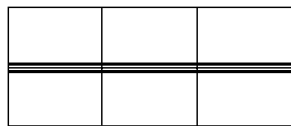

L Configuration

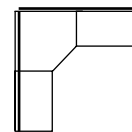

T Configuration

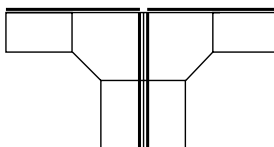

U Configuration

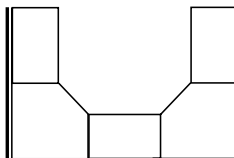

X Configuration

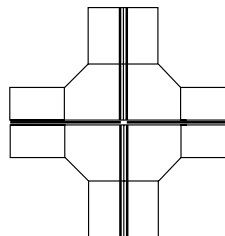

Select from Arlink® 8000 workstation options to best optimize workflow management, including worksurfaces and accessories (task lighting, power, air and data beams, shelving, parts bin racks, etc.).

Single-Sided – operator faces conveyor with standard worksurface

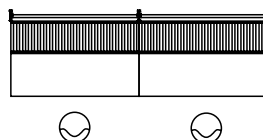

Double-Sided – operator faces conveyor with standard worksurface

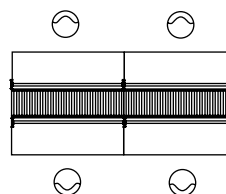

Double-Sided – operator faces conveyor with scalloped worksurface

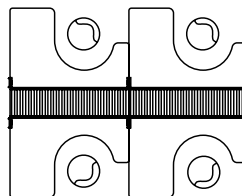

Double-Sided – operator at 90° to conveyor with standard worksurface

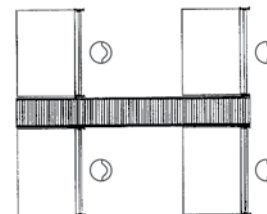

ARLINK 8000 EASY-ORDER COMBINATIONS

The workstation components shown on this page are preconfigured to include our most popular and versatile Arlink® 8000 workstation styles.

Arlink® 8000 workstations consist of a starter section, and as many adder sections as you need for your application.

Select from single- or double-sided starters, adders, or corners in all standard section widths and heights. Easy-Order sections include all accessories shown in the charts to the right.

Single-Sided Starter

Assembly Includes:

- 1 Starter Assembly
- 2 Outriggers
- 1 Worksurface Assembly
- 1 Single-Sided Power Beam (15 Amp)
- 1 Open Wire Shelf Assembly, 12" Depth
- 2 Bulb Light Bulb Fixture Assembly

Single-Sided Adder

Assembly Includes:

- 1 Adder Assembly
- 1 Outrigger
- 1 Worksurface Assembly
- 1 Single-Sided Power Beam (15 Amp)
- 1 Open Wire Shelf Assembly, 12" Depth
- 2 Bulb Light Bulb Fixture Assembly

Single-Sided Corner Adder

Assembly Includes:

- 1 Adder Assembly
- 1 Outrigger
- 1 Worksurface Assembly
- 1 Single-Sided Power Beam (15 Amp)
- 1 Open Wire Shelf Assembly, 12" Depth
- 2 Bulb Light Bulb Fixture Assembly



SINGLE-SIDED STARTERS - STANDARD LAMINATE, 30" DEPTH

COLUMN HEIGHT	30"	36"	48"	60"	72"
54"	9A-SS305430SL	9A-SS365430SL	9A-SS485430SL	9A-SS605430SL	9A-SS725430SL
72"	9A-SS307230SL	9A-SS367230SL	9A-SS487230SL	9A-SS607230SL	9A-SS727230SL
84"	9A-SS308430SL	9A-SS368430SL	9A-SS488430SL	9A-SS608430SL	9A-SS728430SL

SINGLE-SIDED STARTERS—DISSIPATIVE LAMINATE, 30" DEPTH

COLUMN HEIGHT	30"	36"	48"	60"	72"
54"	9A-SS305430SD	9A-SS365430SD	9A-SS485430SD	9A-SS605430SD	9A-SS725430SD
72"	9A-SS307230SD	9A-SS367230SD	9A-SS487230SD	9A-SS607230SD	9A-SS727230SD
84"	9A-SS308430SD	9A-SS368430SD	9A-SS488430SD	9A-SS608430SD	9A-SS728430SD



SINGLE-SIDED ADDERS - STANDARD LAMINATE, 30" DEPTH

COLUMN HEIGHT	30"	36"	48"	60"	72"
54"	9A-SA305430SL	9A-SA365430SL	9A-SA485430SL	9A-SA605430SL	9A-SA725430SL
72"	9A-SA307230SL	9A-SA367230SL	9A-SA487230SL	9A-SA607230SL	9A-SA727230SL
84"	9A-SA308430SL	9A-SA368430SL	9A-SA488430SL	9A-SA608430SL	9A-SA728430SL

SINGLE-SIDED ADDERS — DISSIPATIVE LAMINATE, 30" DEPTH

COLUMN HEIGHT	30"	36"	48"	60"	72"
54"	9A-SA305430SD	9A-SA365430SD	9A-SA485430SD	9A-SA605430SD	9A-SA725430SD
72"	9A-SA307230SD	9A-SA367230SD	9A-SA487230SD	9A-SA607230SD	9A-SA727230SD
84"	9A-SA308430SD	9A-SA368430SD	9A-SA488430SD	9A-SA608430SD	9A-SA728430SD



SINGLE-SIDED CORNER ADDERS - STANDARD LAMINATE, 30" DEPTH

COLUMN HEIGHT	36"
54"	9A-SC365430SL
72"	9A-SC367230SL
84"	9A-SC385430SL

SINGLE-SIDED CORNER ADDERS —DISSIPATIVE LAMINATE, 30" DEPTH

COLUMN HEIGHT	36"
54"	9A-SC365430SD
72"	9A-SC367230SD
84"	9A-SC368430SD

ARLINK 8000 EASY-ORDER COMBINATIONS (CONT)

Double-Sided Starter

Assembly Includes:

- 1 Starter Assembly
- 4 Outriggers
- 2 Worksurface Assemblies
- Double-Sided Power Beam (15 Amp)
- 2 Open Wire Shelf Assemblies, 12" Depth
- 2 Bulb Light Bulb Fixture Assembly



DOUBLE-SIDED STARTERS - STANDARD LAMINATE, 30" DEPTH

COLUMN HEIGHT	30"	36"	48"	60"	72"
54"	9A-DS305430SL	9A-DS365430SL	9A-DS485430SL	9A-DS605430SL	9A-DS725430SL
72"	9A-DS307230SL	9A-DS367230SL	9A-DS487230SL	9A-DS607230SL	9A-DS727230SL
84"	9A-DS308430SL	9A-DS368430SL	9A-DS488430SL	9A-DS608430SL	9A-DS728430SL

SINGLE-SIDED STARTERS—DISSIPATIVE LAMINATE, 30" DEPTH

COLUMN HEIGHT	30"	36"	48"	60"	72"
54"	9A-DS305430SD	9A-DS365430SD	9A-DS485430SD	9A-DS605430SD	9A-DS725430SD
72"	9A-DS307230SD	9A-DS367230SD	9A-DS487230SD	9A-DS607230SD	9A-DS727230SD
84"	9A-DS308430SD	9A-DS368430SD	9A-DS488430SD	9A-DS608430SD	9A-DS728430SD

Double-Sided Adder

Assembly Includes:

- 1 Adder Assembly
- 2 Outriggers
- 2 Worksurface Assemblies
- 1 Double-Sided Power Beam (15 Amp)
- 2 Open Wire Shelf Assemblies, 12" Depth
- 2 Bulb Light Bulb Fixture Assembly



DOUBLE-SIDED ADDERS - STANDARD LAMINATE, 30" DEPTH

COLUMN HEIGHT	30"	36"	48"	60"	72"
54"	9A-DA305430SL	9A-DA365430SL	9A-DA485430SL	9A-DA605430SL	9A-DA725430SL
72"	9A-DA307230SL	9A-DA367230SL	9A-DA487230SL	9A-DA607230SL	9A-DA727230SL
84"	9A-DA308430SL	9A-DA368430SL	9A-DA488430SL	9A-DA608430SL	9A-DA728430SL

SINGLE-SIDED ADDERS—DISSIPATIVE LAMINATE, 30" DEPTH

COLUMN HEIGHT	30"	36"	48"	60"	72"
54"	9A-DA305430SD	9A-DA365430SD	9A-DA485430SD	9A-DA605430SD	9A-DA725430SD
72"	9A-DA307230SD	9A-DA367230SD	9A-DA487230SD	9A-DA607230SD	9A-DA727230SD
84"	9A-DA308430SD	9A-DA368430SD	9A-DA488430SD	9A-DA608430SD	9A-DA728430SD

Double Sided Corner Adder

Assembly includes:

- 1 Starter Assembly
- 2 Outriggers
- 2 Worksurface Assemblies
- 1 Double-Sided Power Beam (15 Amp)
- 2 Open Wire Shelf Assemblies, 12" Depth
- 2 Bulb Light Bulb Fixture Assembly



DOUBLE-SIDED ADDERS - STANDARD LAMINATE, 30" DEPTH

COLUMN HEIGHT	36"
54"	9A-DC365430SL
72"	9A-DC367230SL
84"	9A-DC368430SL

SINGLE-SIDED ADDERS—DISSIPATIVE LAMINATE, 30" DEPTH

COLUMN HEIGHT	36"
54"	9A-DC365430SD
72"	9A-DC367230SD
84"	9A-DC368430SD

BUILD YOUR OWN WORKSTATION

Designing a custom Arlink® 8000 workstation is a simple and straight forward process.

Start by selecting the structural elements (starter and adder assemblies), add outriggers, choose worksurface(s), and add the accessories that fulfill your needs.

In addition to the column heights shown, columns can be custom cut to any size you request.

1. Select starter assembly (length and height)
2. Select adder assemblies (length and height)
3. Select outriggers or Select mobile starter base
4. Select appropriate worksurface assemblies
5. Select accessories



STARTER ASSEMBLY COLUMN HEIGHT	24"	30"	36"	48"	60"	72"
54"	9829	9692	9897	9896	9601	9702
72"	9831	9694	9901	9900	9600	9700
84"	9833	9696	9903	9902	9603	9704

ADDER ASSEMBLY COLUMN HEIGHT	24"	30"	36"	48"	60"	72"
54"	9830	9693	9899	9898	9606	9703
72"	9832	9695	9906	9905	9605	9701
84"	9834	9697	9908	9904	9608	9705



STARTER ASSEMBLY - OPEN STABILIZER COLUMN HEIGHT	24"	30"	36"	48"	60"	72"
54"	09829	09692	09897	09896	09601	09702
72"	09831	09694	09901	09900	09600	09700
84"	09833	09696	09903	09902	09603	09704

ADDER ASSEMBLY - OPEN STABILIZER COLUMN HEIGHT	24"	30"	36"	48"	60"	72"
54"	09830	09693	09899	09898	09606	09703
72"	09832	09695	09906	09905	09605	09701
84"	09834	09697	09908	09904	09608	09705

BUILD YOUR OWN WORKSTATION



Outriggers

OUTRIGGERS

22" (24"-30" W/SFC)	8066
30" (36" W/SFC)	8073
15" (SHELVING & CORNERS)	8078



Mobile Base Starter

MOBILE BASE-SINGLE SIDED

	24"	30"	36"	48"	60"	72"
STARTER	9997SS	9313SS	9969SS	9968SS	9668SS	9768SS
ADDER	9997SA	9313SA	9969SA	9968SA	9668SA	9768SA



Mobile Base Adder

Column Cap

- Redesigned to provide a more positive and secure attachment to the column
- Material thickness has been increased and color will be matched to the steel paint color
- Included on all columns 54"h or shorter and is optional on all other heights



Column Cap

PART NO.
8006

Back Stops

- Steel back stop prevents items from rolling off worksurface.
- 3" high.
- Mounts in micro slots, adjusts vertically in 1" increments.



BACK STOPS LENGTH

BACK STOPS LENGTH	PART NO.
24"	8962
30"	8449
36"	8461
48"	8463
60"	8466
72"	8468

ARLINK 8000 WORKSTATION WORKSURFACES

Plastic Laminate Worksurface Assemblies

Worksurface is constructed of 1" thick medium density particle board covered on top and all sides with non-glare matte finish plastic laminate. Assembly includes 2 worksurface support brackets and 2 worksurface support beams.

Color:

- Dove gray
- Antique white

Static Dissipative Laminate Worksurface Assemblies

Worksurface is the same as the plastic laminate worksurface, but with plastic laminate that provides a controlled path to ground for the dissipation of static electricity. The worksurface is provided with a grounding kit that must be used to provide proper protection for components and personnel. Static dissipative value for the material is 10^6 – 10^9 . Assembly includes 2 worksurface support brackets and 2 worksurface support beams.

Color:

- Dove gray
- Almond

Also available:

- Butcher block (1 1/4" thick)
- Phenolic resin (1" thick)
- Stainless steel (1 1/8" thick)



WORKSURFACE ASSEMBLY—STANDARD LAMINATE

	24"	30"	36"	48"	60"	72"
24"	9251	9551	9351	9451	9651	9751
28"	9815	9729	9924	9923	9620	9715
30"	9818	9730	9SA101	9SA105	9SA109	9SA113
36"	9813	9733	9SA104	9SA108	9SA112	9SA116

CORNER WORKSURFACE ASSEMBLY—ADJACENT WORKSURFACE—SQ. BACK, STANDARD LAMINATE

	24"	28"	30"	36"
30" MODULE	9950	9722	9748	N/A
36" MODULE	9951	9812	9SA200	9SA203
48" MODULE	9956	9864	9SA224	9SA227
ROUND BACK CORNER	9966	9806	9SA216	9SA219
REAR SUPPORT POST	9094			

WORKSURFACE ASSEMBLY—ESD LAMINATE

	24"	30"	36"	48"	60"	72"
24"	9251SD	9551SD	9351SD	9451SD	9651SD	9751SD
28"	9816	9754	9994	9992	9622	9716
30"	9819	9755	9SA155	9SA159	9SA163	9SA167
36"	9827	9758	9SA158	9SA162	9SA166	9SA170

CORNER WORKSURFACE ASSEMBLY—ADJACENT WORKSURFACE—ESD LAMINATE

	24"	28"	30"	36"
30" MODULE	9950SD	9722SD	9748SD	N/A
36" MODULE	9951SD	9814	9SA204	9SA207
48" MODULE	9956SD	9865	9SA228	9SA231
ROUND BACK CORNER	9966SD	9808	9SA220	9SA223
REAR SUPPORT POST	9094			



WORKSURFACE ASSEMBLY—BUTCHER BLOCK

	24"	30"	36"	48"	60"	72"
24"	9251BB	9551BB	9351BB	9451BB	9651BB	9751BB
28"	9815BB	9729BB	9924BB	9923BB	9620BB	9715BB
30"	9818BB	9730BB	9SA101BB	9SA105BB	9SA109BB	9SA113BB
36"	9813BB	9733BB	9SA104BB	9SA108BB	9SA112BB	9SA116BB

CORNER WORKSURFACE ASSEMBLY—ADJACENT WORKSURFACE DEPTH—BUTCHER BLOCK

	24"	28"	30"	36"
30" X 30"	9950BB	9722BB	9748BB	N/A
36" X 36"	9951BB	9812BB	9SA200BB	9SA203BB
48" X 48"	9956BB	9864BB	9SA224BB	9SA227BB
ROUND BACK CORNER	9966BB	9806BB	9SA216BB	9SA219BB
REAR SUPPORT POST FOR SQ. BACK CORNER	9094			

HANGING DRAWERS AND CPU HOLDERS

Hanging Drawer

- Steel drawer mounts under worksurface, and can slide to any horizontal position
- Includes steel ball bearing slides and recessed handles
- 100% full extension
- Each unit comes with a lock and 2 keys
- Keyed-alike and master locks are available. 16 3/4" wide. Usable inside dimensions: 13 1/4" wide x 16 15/16" deep

Usable heights can be found in chart

Lap Drawer/Pencil Drawer

- 21 3/8" wide x 18 3/4" deep
- Lock not available
- Steel ball bearing slides and full length integrated handle



WORKSURFACE DEPTH

HANGING CABINET, TWO 2 3/4"D, ONE 5 3/4"H DRAWERS	4841
HANGING CABINET, FOUR 2 3/4" H DRAWERS	4842
HANGING CABINET, TWO 2 3/4"H, ONE 13 15/15"D FILE DRAWERS	4855
HANGING CABINET, TWO 2 3/4"H DRAWERS, TWO 5 3/4"D DRAWERS	4856
HANGING CABINET, SINGLE 5 3/4"H DRAWER	8619
HANGING CABINET, TWO 2 3/4"H DRAWERS	8626
HANGING CABINET, SINGLE 13 15/15"H FILE DRAWER,	8634
HANGING CABINET, TWO 5 3/4"H DRAWERS	8639
HANGING CABINET, ONE 5 3/4"H, ONE 13 15/15"D FILE DRAWERS	8658
HANGING CABINET, THREE 5 3/4"H DRAWERS	8664
LAP DRAWER	4850

DRAWER PULL OPTIONS

Hanging Cabinet Tech Drawer Pull (Chrome Color)	4875-CHRM
Hanging Cabinet Tech Drawer Pull (Brushed Silver)	4875-BRSH
Hanging Cabinet Tech Drawer Pull (Gloss Black)	4875-GBLK

Pelican Drawer

- Secure storage for legal hanging files or personal effects, plus segmented tray for pencils, pens, paper clips, etc.
- Designed to allow easy clearance for worker's knees
- Thermo-formed polystyrene body with polyurethane drawer face
- Mounts under worksurface to worksurface support beams
- Includes concealed ball bearing slides and fully integrated locking system



PART NO.

8845

ARLINK 8000 FLOW RACKS

Flow racks can be used to stage and deliver parts utilizing gravity, reducing material handling time and costs. Bins or totes are loaded on flow rack frames from the rear, and as operators remove one from the front, a new bin glides forward on rollers. Similarly, flow rack frames can be inclined away from an operator to allow removal of completed work.

Flow racks are constructed utilizing the same Starter and Adder system common to all Arlink 8000 workstations. Worksurface assemblies and accessories as shown in this catalog can be added to create a complete parts presentation and integrated workstation system. Ball transfer tables, other material handling worksurfaces or conveyors may also be integrated into the worksurface as needed. Flow racks can be made mobile by the addition of caster sets.

Flow rack sections may be joined side by side, using Starter and Adder assemblies to achieve any overall length and combination of section sizes.

Arlink 8000 Flow Racks

- Arlink 8000 flow racks sections are available in 4 standard widths from 30" to 60"
- Flow racks are height adjustable in 1" increments
- The flow rack angle is adjustable, 1400 lb. weight capacity

Arlink 8000 Flow Rack Starter Assemblies

- Consists of 2 starter assemblies, 2 outriggers, 1 flow rack shelf assembly and 4 connectors

Arlink 8000 Flow Rack Adder Assemblies

- Consists of 1 adder assembly, 1 outrigger, 1 flow rack shelf assembly and 2 connectors

Arlink 8000 Flow Rack Shelf Assemblies

- Shelf assembly includes roller tracks and guides as shown
- 3" high, 48" deep, 600 lb. weight capacity
- For additional roller tracks and guides, see chart to right

Arlink 8000 Flow Rack Shelf Accessories

- Shelves are slotted on 1 1/2" increments to accept roller tracks and guides
- Guides separate sections
- Rollers are 1 1/16" wide; tracks are 1" wide
- Two rollers are recommended for rows up to 15" wide, and 3 or more for wider rows



Arlink 8000 Flow Rack Starter Assemblies

PART NO.	SIZE
FRS3072	30" wide x 48" deep
FRS3672	36" wide x 48" deep
FRS4872	48" wide x 48" deep
FRS6072	60" wide x 48" deep

84" HIGH	
FRS3084	30" wide x 48" deep
FRS3684	36" wide x 48" deep
FRS4884	48" wide x 48" deep
FRS6084	60" wide x 48" deep

Arlink 8000 Flow Rack Adder Assemblies

PART NO.	SIZE
FRA3072	30" wide x 48" deep
FRA3672	36" wide x 48" deep
FRA4872	48" wide x 48" deep
FRA6072	60" wide x 48" deep

84" HIGH	
FRA3084	30" wide x 48" deep
FRA3684	36" wide x 48" deep
FRA4884	48" wide x 48" deep
FRA6084	60" wide x 48" deep

Arlink 8000 Flow Rack Shelf Assemblies

PART NO.	WIDTH	INCLUDES
FR30	30"	4 roller tracks, 1 guide
FR36	36"	4 roller tracks, 1 guide
FR48	48"	6 roller tracks, 2 guides
FR60	60"	6 roller tracks, 2 guides

Arlink 8000 Flow Rack Shelf Accessories

PART NO.	DESCRIPTION
FRTR	roller track
FRGU	roller guide
FRCP	replacement clip

ARLINK 8000 UTILITY AND PARTS CARTS

Single- or double-sided modular carts can be configured with any combination of shelves, parts bins, utility bins, etc. to meet your exact needs. All are constructed using Lista's standard Arlink 8000 column to allow complete interchangeability of components with workstations.

Utility and Parts Carts

- 54" high carts feature 2 wheel-locking and 2 non-locking casters, 3 ½" diameter
- Wheels are rubber, non-marking

Accepts:

- Shelves – maximum shelf depth for parts cart is 14"
- Pegboard, louvered, reversible and modesty panels
- Bin rails
- Power, air and data beams
- Pivoting accessories



Utility and Parts Carts

PART NO.	SECTION LENGTH
SINGLE-SIDED	
8326SS	30"
8915SS	36"
8964SS	48"
DOUBLE-SIDED	
8326DS	30"
8915DS	36"
8964DS	48"



ARLINK 7000 AND 8000 SHELVES

Open Wire Shelf

- Welded steel wire shelf has chrome plated finish
- Adjusts from horizontal to 15° and 30° inclination
- Includes front lip (can be oriented up or down)
- Weight capacity 150 lbs.
- Available with micro and macro slot brackets



Open Wire Shelf-Macro Slot

VSI-8 COLUMNS	30"	36"	48"	60"	72"
12" D	8884	8927	8925	8625	8725
9" D LAB	4581	4381	4481	4681	4781

Open Wire Shelf-Micro Slot

VSI-8 AND VSI-1 COLUMNS	30"	36"	48"	60"	72"
12" D	7Z1057	7Z1058	7Z1059	7Z1060	7Z1061
9" D LAB	4282	4382	4482	4682	4782

Light Duty Adjustable Steel Shelf

- Mount flat or at a 15° angle
- Mount with the lip to the front or back
- 100 lb. weight capacity
- Available only with micro slot bracket



Light Duty Shelf

VSI-8 AND VSI-1 COLUMNS	24"	30"	36"	42"	48"	60"
12" D	7Z1166	7Z1167	7Z1168	7Z1177	7Z1169	7Z1170
15" D	7Z1178	7Z1172	7Z1173	7Z1182	7Z1174	7Z1175

Steel Shelf

- Adjusts from horizontal to 15 degree and 30 degree inclination with macro brackets and from horizontal to 15 degree with micro brackets.
- Marco slot shelves have weight capacity of 300 lbs.
- Micro slot shelves have weight capacity of 150 lbs.



Steel Shelf-Macro Slot

VSI-8 COLUMNS	24"	30"	36"	42"	48"	60"	72"
12" D	4260	4560	4360	4160	4460	4660	4760
16" D	4261	4561	4361	4161	4461	4661	4761
20" D	4262	4562	4362	4162	4462	4662	4762

Steel Shelf-Micro Slot

VSI-8 AND VSI-1 COLUMNS	24"	30"	36"	42"	48"	60"	72"
12" D	7Z2021	7Z2022	7Z2023	7Z2024	7Z2025	7Z2026	7Z2027
16" D	7Z2031	7Z2032	7Z2033	7Z2034	7Z2035	7Z2036	7Z2037
20" D	7Z2041	7Z2042	7Z2043	7Z2044	7Z2045	7Z2046	7Z2047

Shelf Lips

	24"	30"	36"	42"	48"	60"	72"
	4265	4565	4365	4165	4465	4665	4765

Steel Shelf Dividers

	12" D	16" D	20" D
8"	4120-12	4120-16	4120-20
12"	4121-12	4121-16	4121-20

Variable Angle Shelf

- Shelf mounts in forward or set back position
- Adjusts variably from totally flat to 25° angle and has a full perimeter lip
- 150 lb. capacity
- Shelf without lip is similar to variable angle shelf but includes pre-punched holes to accept vertical wire dividers
- Mounts in micro slots, adjusts vertically in 1" increments



Variable Angle Shelf

VSI-8 AND VSI-1 COLUMNS	24"	30"	36"	42"	48"	60"
18" D	8232	8312	8328	8342	8327	8497
24" D	8233	8314	8355	8378	8354	N/A

ARLINK 7000 AND 8000 WORKSTATION LIGHTING ACCESSORIES

Dual Lamp Fluorescent Light Assembly

- Economical twin tube fluorescent light fixture
- Uses economical T-8 lamps and electronic ballasts and come with a 9ft power cord
- Color temperature is 4100K
- Output: 80 footcandles (861 lumens)



	30"	36"	42"	48"	60"	72"
2 BULB T8 FLUORESCENT 19" MICRO BRACKET	9511L	9533L	9679L	9534L	9655L	9784L
2 BULB T8 FLUORESCENT 26" MICRO BRACKET	9511XL	9533XL	9679XL	9534XL	9655XL	9784XL

LED Overhead Light Assembly

- Overhead task lighting is available with a choice of 2 micro slot mounting brackets, 19" and 26"
- The 26" bracket is recommended for deeper worksurfaces and when being used over the deeper shelves
- Color Temp 5000K
- CRI 90
- Average Output 1500 Lumens (measured at surface - light 41" above)



	30"	36"	42"	48"	60"	72"
LED FIXTURE 19" MICRO BRACKET	8524L	8527L	8419L	8531L	8621L	8788L
FIXTURE 26" MICRO BRACKET	8524XL	8527XL	8419XL	8531XL	8621XL	8788XL

Switchable 4 Lamp Fluorescent Light Assembly

- Switchable 2 or 4 tube fluorescent light fixture allows user to select light intensity according to the task
- Uses energy saving T5 lamps and electronic ballasts
- Comes complete with (4) 32 watt lamps and acrylic diffuser
- Fixture tilts up or down 10°
- Includes 9' power cord



Arlink 7000

	30"	36"	42"	48"	60"	72"
4 BULB T5 FLUORESCENT 19" MICRO BRACKET	N/A	7Z2015L	N/A	7Z2014L	7Z2016L	7Z2017L
4 BULB T5 FLUORESCENT 26" MICRO BRACKET	N/A	7Z2015XL	N/A	7Z2014XL	7Z2016XL	7Z2017XL

Arlink 8000

	36"	48"	60"	72"
4 BULB T5 FLUORESCENT 19" MACRO BRACKET	4375L	4475L	4675L	4775L
4 BULB T5 FLUORESCENT 26" MACRO BRACKET	4375XL	4475XL	4675XL	4775XL

Task Light Bracket

- Sturdy welded steel bracket mounts in micro slot with 1/2" diameter hole for task light

COLUMN MOUNTING BRACKET 9"	8130
COLUMN MOUNTING BRACKET 15"	8132

ARLINK 7000 AND 800 COMPUTER RELATED ACCESSORIES

CPU Holder

- Allows CPU to be mounted under the worksurface, off the floor
- Mounts to worksurface support beams



CPU Holder Arlink 7000

30" D W/SFC	36" D W/SFC
7L7000	7L7001

Arlink 8000

8440

Adjustable CPU Holder

- Adjustable pullout CPU holder has 360° rotation
- Accommodates CPU width range of 2"-8 1/2" and CPU height range of 11" - 22"
- Mounts to worksurface support beams



Adjustable CPU Holder Arlink 7000

30" D W/SFC	36" D W/SFC
7L7004	7L7005

Arlink 8000

8424

Articulating Keyboard Tray

- Tilttable keyboard holder allows computer keyboard to be stored under worksurface when not in use
- Includes swivel pull-out mouse pad which can be attached to either right or left side



Articulating Keyboard Tray Arlink 7000

30" D W/SFC	36" D W/SFC
7Z1011-30	7Z1011-36

Arlink 8000

8451

Pull Out Keyboard Tray

- Pull out keyboard holder is available in 2 sizes; 20" x 14" and 27" x 14" which will accommodate a mouse in addition to the keyboard
- Mounts to underside of worksurface



Pull Out Keyboard Tray

PART NO.	L X W
8649	20" x 14"
8656	27" x 14"

ARLINK 7000 AND 8000 PIVOTING ACCESSORIES

Equipment Shelves

- Holds a variety of customer-supplied equipment or tools
- Single Arm; 75 lb. capacity
- Double Articulating Arm; 50 lb. capacity



Equipment Shelves

PART NO.	DESCRIPTION
8857	12 3/8" wide x 12 3/8" deep
8839	with double articulating arm

Accessory Shelves

- For easy access to small tools, instruments, parts, etc. 21 1/4" wide x 7 3/8" deep
- Single Arm; 75 lb. capacity
- Double Articulating Arm; 50 lb. capacity
- Ribbed rubber mat optional



Accessory Shelves

PART NO.	DESCRIPTION
8887	accessory shelf
8765	with double articulating arm
8759	ribbed rubber mat

Document Holders

- For displaying papers, plans, etc. Includes lip for pencils, pens, etc.



Document Holders

PART NO.	DESCRIPTION
8666	11 7/8" wide x 13 3/4" high
8776	with double articulating arm

Large Document Holders

- For displaying large documents, and open binders and books
- Includes lip for pencils, pens, etc.



Large Document Holders

PART NO.	DESCRIPTION
8670	23 5/8" wide x 13 3/4" high
8786	with double articulating arm

ARLINK 7000 AND 8000 ELECTRICAL ACCESSORIES

Horizontal Power Beams

- All power beams include lighted on/off switch, breaker and 7 ½' power cord
- 15 amp beams available in single- and double-sided configurations
- Mounts in micro slots, adjusts vertically in 1" increments



	24"	30"	36"	42"	48"	60"	72"
SINGLE-SIDED - 15 AMP	4290	4590	4390	4190	4490	4690	4790
SINGLE-SIDED - 15 AMP-W/USB	4291	4591	4391	4191	4491	4691	4791
SINGLE-SIDED - 15 AMP-W/GFCI	4292	4592	4392	4192	4492	4692	4792
SINGLE-SIDED - 20 AMP	4293	4593	4393	4193	4493	4693	4793
SINGLE-SIDED - 20 AMP-W/USB	4294	4594	4394	4194	4494	4694	4794
SINGLE-SIDED - 20 AMP-W/GFCI	4295	4595	4395	4195	4495	4695	4795
DOUBLE-SIDED - 15 AMP	4296	4596	4396	4196	4496	4696	4796
Outlets per side	4	6	8	8	10	10	10

Vertical Power Strips

- Available in 15 amp or 20 amp, and GFCI
- Lighted on/off switch, 6' cord with grounded plug and circuit breaker included
- Painted black
- Mounts vertically to front and back of micro slots, adjusts vertically in 1" increments
- Bracket and hardware supplied



Vertical Power Strips

	VSI-1	VSI-8
15 AMP WITH 6 OUTLETS	7Z1062	8942
20 AMP WITH 6 OUTLETS	7Z1063	8943
15 AMP GFCI WITH 6 OUTLETS	7Z1064	8947
20 AMP GFCI WITH 6 OUTLETS	7Z1065	8948

ARLINK 7000, 8000, AND VSI PANELS

Solid Privacy Panels

- Steel modesty panel acts as a privacy screen between double-sided assemblies (or single-sided where required)
- Steel panels can be used as fill-in panel or magnet panel to hold instructions or drawings
- Mounts in micro slots, adjusts vertically in 1" increments
- Available in 12"H, 18"H, and 30"H



	24"	30"	36"	42"	48"	60"	72"
SOLID PRIVACY PANEL (12"H)	8820	8891	8803	8810	8804	8805	8727
SOLID PRIVACY PANEL (18"H)	8764	8142	8126	8128	8123	8465	8529
SOLID PRIVACY PANEL (30"H)	8777	8364	8356	8375	8357	8358	N/A

Pegboard Panels

- Sturdy painted steel pegboard panel, ideal for hanging tools, etc.
- Mounts in micro slots, adjusts vertically in 1" increments
- Available in 18"H, and 30"H

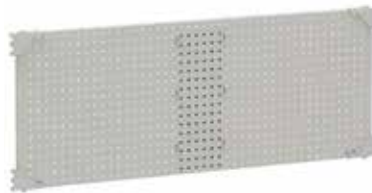

	24"	30"	36"	42"	48"	60"	72"
PEGBOARD PANEL (18"H)	8332	8333	8334	8306	8335	8336	8337
PEGBOARD PANEL (30"H)	8087	8088	8089	8083	8090	8091	N/A

Louvered Panels

- Sturdy painted steel louvered panel, holds hanging plastic bin boxes, tool or supply holders
- Mounts in micro slots, adjusts vertically in 1" increments
- Available in 18"H and 30"H



	24"	30"	36"	42"	48"	60"	72"
LOUVERED PANEL (18"H)	8441	8442	8443	8433	8444	8445	8447
LOUVERED PANEL (30"H)	8811	8598	8599	8616	8999	8654	N/A

Reversible Markerboard/Tackboards

- Two-sided reversible board
- Features white magnetic markerboard on 1 side and gray fabric tackboard on the other
- Also functions as privacy panel and sound dampener
- 30" high
- Mounts in micro slots, adjusts vertically in 1" increments



	24"	30"	36"	42"	48"	60"
MARKER BOARD/TACKBOARD 30"H	8767	8771	8772	8797	8773	8774

Panel Joiner Kit

- Panel joiner kit enables building combo panels without the need for split bay upright
- 12" AND 18" Pegboard, louvered and solid privacy panels can be combined to span 48", 60" and 72" spaces
- Panel joiner kit cannot be used with markerboard/tackboards



12"H	18"H
8329-12	8329-18



ARLINK 7000, 8000 AND VSI WORKSTATION STORAGE AND TOOL ACCESSORIES

Overhead Cabinets

- Steel cabinet with retractable locking door
- Includes mounting brackets, lock and 2 keys
- Keyed-alike or master lock systems are available
- Mounts in micro slots, adjusts vertically in 1" increments
- Overhead cabinet is 15" deep with a internal usable depth of 13.5"



	24"	30"	36"	42"	48"	60"	72"
OVERHEAD CABINETS	8921	8297	8956	8310	8955	8650	8760

Heavy-Duty Parts Bin Rails

- Heavy duty parts bin rail holds heavier items such as hardware, fittings, etc. and is easily adjustable for ergonomic access
- It can be mounted parallel to the worksurface or at a 15° angle
- Mounts in micro slots, adjusts vertically in 1" increments



	24"	30"	36"	42"	48"	60"	72"
HEAVY DUTY - TILTABLE 2"	8217	8223	8225	8222	8226	8475	8546
HEAVY DUTY - TILTABLE 4"	8258	8259	8261	8264	8260	8499	8717

Utility Bins

- Full length steel bin holds tools, bottles, wipes, reeled solder dispenser, etc.
- Front edge can be used as a parts bin rail
- Mounts in micro slots, adjusts vertically in 1" increments



	24"	30"	36"	42"	48"	60"	72"
UTILITY BINS	8248	8299	8247	8207	8246	8446	8578

ARLINK 7000 AND 8000 WORKSTATION STORAGE AND TOOL ACCESSORIES

Tool and Accessory Holders

- Tool and accessory holders add convenience to the workplace
- They hang on parts bin rail or utility bin and can be positioned for easy reach

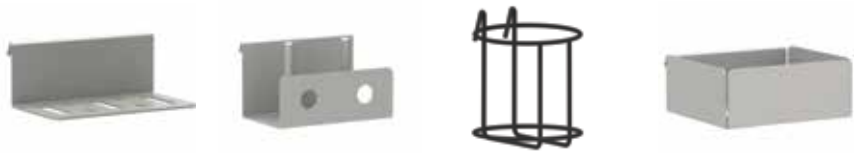

TOOL HOLDER	8277
SOLDER SPOOL HOLDER	8276
BOTTLE HOLDER	8281
KIM WIPE HOLDER	8275

Airgun Holder

- Mounts to work- surface support beam
- 1 1/2" x 1 1/2" with 1" diameter hole



AIRGUN HOLDER	4863
---------------	------

Wire Holder Assemblies

- Assembly includes support brackets (pair) and wire holder – 3/4" tube with threaded inserts
- Mounts in micro slots, adjusts vertically in 1" increments



	24"	30"	36"	48"	60"	72"
WIRE HOLDER ASSEMBLIES	8926	8886	8928	8929	8685	8785
WIRE GUIDE	8954	8301	8274	8273	8471	8583

Wire Guides

- Chrome plated bar with several holes, guides wire on the job without tangling or de-railing
- Mounts in micro slots, adjusts vertically in 1" increments

Label/Roll Holders

- Includes 1" diameter rod and brackets
- Rod is unpainted galvanized steel; brackets are painted to match frame
- 100 lb. weight capacity
- Interior mount available for dispensing labels and other smaller rolls
- Extended mount available for dispensing paper, bubble rolls, etc.



	24"	30"	36"	42"	48"	60"	72"
LABEL/ ROLL HOLDER (INTERIOR MOUNT)	4266	4566	4366	4166	4466	4666	4766
LABEL/ ROLL HOLDER (EXTENDED MOUNT)	4267	4567	4367	4167	4467	4667	4767

Tool Glide Track and Trolley Assemblies

- Smooth-moving glide keeps electric and pneumatic tools properly positioned
- If used in conjunction with fluorescent light assembly, glide track mounts on brackets for fluorescent lights



	24"	30"	36"	42"	48"	60"	72"
TOOL GLIDETRACK AND TOLLEY ASSEMBLIES	N/A	9958	9975	N/A	9976	9633	9728
ADDITIONAL TOOL TROLLEY	8184						

Data Beams

- Modular data beams feature 2 duplex-style outlets with 8 ports that accept modular snap-in/snap-out jacks or connectors for data, video, or audio connectivity
- Beams come with outlets, but jacks/connectors must be purchased separately
- On-site wiring for ports is responsibility of customer
- Mounts in micro slots, adjusts vertically in 1" increments
- Contact Lista for additional specifying assistance



DATA BEAMS	24"	30"	36"	42"	48"	60"	72"
SINGLE-SIDED	4288	4588	4388	4188	4488	4688	4788
DOUBLE-SIDED	4289	4589	4389	4189	4489	4689	4789

Air Beams

Air beam is supplied with:

- (1) 1/4" NPT female inlet on top
- (2) 1/4" NPT female outlets on front (single-sided) and (2) 1/4" NPT female outlets per side (double-sided) for 24" and 30" beams
- (3) 1/4" NPT female outlets on front (single-sided) and (3) 1/4" NPT female outlets per side (double-sided) for 36", 48", 60" and 72" beams
- (2) end mounted jumpers
- Mounts in micro slots, adjusts vertically in 1" increments



AIR BEAMS	24"	30"	36"	42"	48"	60"	72"
SINGLE-SIDED	8913	8879	8949	8846	8950	8951	8750
DOUBLE-SIDED	8914	8853	8977	8852	8978	8660	8751

Cable Trays

- Tray neatly gathers bundles of loose horizontal wires and provides random access for cable routing along its length
- Painted black
- Mounts in micro slots, adjusts vertically in 1" increments



CABLE TRAYS	24"	30"	36"	42"	48"	60"	72"
CABLE TRAYS	N/A	8302	8389	N/A	8390	8498	8597
CABLE CLIP	8391						

Air Supply Bracket

- Supplied with (1) 1/4" NPT female outlet
- Mounts under worksurface to worksurface support beam
- Single outlet



Air Supply Bracket

PART NO.
4866

Wrist Strap and Ground Block

- Mounts under worksurface to worksurface or support beams
- Dual receptacles for 2 wrist straps



Wrist Strap and Ground Block

PART NO.	DESCRIPTION
SC12	ground block
SC15	wrist strap with 6' cord*

* with 1 megohm resistor

Ground Kits

- Kit is supplied with all static dissipative worksurfaces or shelves
- Includes attaching hardware

Ground Kits

PART NO.	DESCRIPTION
SC10	worksurface kit with 8' cord*
SC30	shelf kit with 6' cord**

* with 1 megohm resistor

** without 1 megohm resistor

Common Point Ground Block

- Two connection sides – one side connects to a 1 megohm resistor, the other side bypasses the resistor and connects directly to ground
- Includes 8' cord



Common Point Ground Block

PART NO.
SC14

FLAT PANEL MONITOR ARMS (ARLINK & NEXUS)

Basic Flat Panel Monitor Arm: Horizontal Articulation; Column Mount

- Articulates horizontally
- Factory pre-tensioned articulated head
- Factory pre-tensioned joints
- Vesa 75/100 interface plate
- Supports up to 18 lbs. (8kg)
- Maximum reach 16" (407mm)
- Mounts to Arlink 8000 /VSI-8 and VSI-1/ Nexus uprights



Basic Dual Flat Panel Monitor Arm

ARLINK 8000 /VSI-8 PART NO.	VSI-1/ NEXUS PART NO.	DESCRIPTION	WEIGHT
4037	NX4037	Basic Flat Panel Monitor Arm, Column Mount	6 lbs.

Basic Dual Flat Panel Monitor Arm: Horizontal Articulation; Column Mount

- Articulates horizontally
- Factory pre-tensioned articulated head
- Factory pre-tensioned joints
- Vesa 75/100 interface plate
- Supports up to 18 lbs. (8kg) per arm
- Maximum reach 16" (407mm)
- Mounts to Arlink 8000 /VSI-8 and VSI-1/ Nexus uprights



Basic Dual Flat Panel Monitor Arm

ARLINK 8000 /VSI-8 PART NO.	VSI-1/ NEXUS PART NO.	DESCRIPTION	WEIGHT
4045	NX4045	Basic Dual Flat Panel Monitor Arm, Column Mount	12 lbs.

Basic Flat Panel Monitor Arm: Horizontal Articulation; Post Mount

- Articulates horizontally
- Factory pre-tensioned articulated head
- Factory pre-tensioned joints
- Vesa 75/100 interface plate
- Supports up to 18 lbs. (8kg)
- Maximum reach 16" (407mm)
- Solid 1" diameter 13" high aluminum post
- Mounts through worksurface, hole diameter 1/2"



Basic Flat Panel Monitor Arm

ARLINK 8000 /VSI-8 PART NO.	VSI-1/ NEXUS PART NO.	DESCRIPTION	WEIGHT
4054	NX4054	Basic Flat Panel Monitor Arm, Post Mount	6 lbs.

FLAT PANEL MONITOR ARMS (ARLINK & NEXUS) (CONT)

Gas Assist Tablet Arms

- Mount in microslots
- Dual cylinders with adjustable brake
- Provides easy fluid movement with fingertip control
- Supports 2–5 lbs.
- 16.7" maximum reach



Gas Assist Tablet Arms

	ARLINK 8000/VSI-8 COLUMN MOUNT	ARLINK 8000 POST MOUNT	VSI-1/NEXUS COLUMN MOUNT	NEXUS POST MOUNT
iPad 2,3,4	4047	4081	NX4047	NX4081
iPad Air	4057	4082	NX4057	NX4082
iPad Mini	4058	4083	NX4058	NX4083

Basic Dual Flat Panel Monitor Arm: Horizontal Articulation; Post Mount

- Articulates horizontally
- Factory pre-tensioned articulated head
- Factory pre-tensioned joints
- Vesa 75/100 interface plate
- Supports up to 18 lbs. (8kg) per arm
- Maximum reach 16" (407mm)
- Solid 1" diameter 13" high aluminum post
- Mounts through worksurface, hole diameter 1/2"



Basic Dual Flat Panel Monitor Arm

ARLINK 8000 /VSI-8 PART NO.	VSI-1/ NEXUS PART NO.	DESCRIPTION	WEIGHT
4060	NX4060	Basic Dual Flat Panel Monitor Arm, Post Mount	18 lbs.

Flat Panel Monitor Arms

- For attaching flat panel monitor to upright
- 17 1/2 lb. capacity
- Mounts in macro slots, adjusts vertically in 3" increments *Includes mounting bracket
- Swings left and right, and has 2 articulating points
- Option to include a 9" extender which allows positioning of monitor screen away from adjacent accessories



Flat Panel Monitor Arms

ARLINK 8000 /VSI-8 PART NO.	VSI-1/ NEXUS PART NO.	DESCRIPTION
8415	NX8415	attaches to column
8628	NXA/FPMA	includes 9" bracket extender

FLAT PANEL MONITOR ARMS (ARLINK & NEXUS) (CONT)

Full Function Flat Panel Monitor Arm: Vertical and Horizontal Articulation; Column Mount

- 6 lockable positions for arm and Vesa plate
- Articulates horizontally and vertically
- Factory pre-tensioned articulated head
- Vesa 75/100 interface plate
- Supports up to 26 lbs. (12kg)
- 12" height adjustment
- Maximum reach of 15.9" (404mm)
- Mounts to Arlink 8000 /VSI-8 and VSI-1/ Nexus uprights



Full Function Flat Panel Monitor Arm

ARLINK 8000 /VSI-8 PART NO.	VSI-1/ NEXUS PART NO.	DESCRIPTION	WEIGHT
4036	NX4036	Full Function Flat Panel Monitor Arm, Column Mount	8 lbs.

Full Function Dual Flat Panel Monitor Arm: Vertical and Horizontal Articulation; Column Mount

- 6 lockable positions for arm and Vesa plate
- Articulates horizontally and vertically
- Factory pre-tensioned articulated head
- Vesa 75/100 interface plate
- Supports up to 26 lbs. (12kg) per arm
- 12" height adjustment
- Maximum reach of 15.9" (404mm)
- Mounts to Arlink 8000 /VSI-8 and VSI-1/ Nexus uprights



Full Function Flat Panel Monitor Arm

ARLINK 8000 /VSI-8 PART NO.	VSI-1/ NEXUS PART NO.	DESCRIPTION	WEIGHT
4044	NX4044	Full Function Dual Flat Panel Monitor Arm, Column Mount	16 lbs.

Full Function Flat Panel Monitor Arm: Vertical and Horizontal Articulation; Post Mount

- 6 lockable positions for arm and Vesa plate
- Articulates horizontally and vertically
- Factory pre-tensioned articulated head
- Vesa 75/100 interface plate
- Supports up to 26 lbs. (12kg)
- 12" height adjustment
- Maximum reach of 15.9" (404mm)
- Solid 1.5" diameter 15.75" high aluminum post
- Mounts through worksurface, hole diameter 1/2"



Full Function Flat Panel Monitor Arm

ARLINK 8000 /VSI-8 PART NO.	VSI-1/ NEXUS PART NO.	DESCRIPTION	WEIGHT
4053	NX4053	Full Function Flat Panel Monitor Arm, Post Mount	8 lbs.

Keyboard Holder for Flat Panel Monitor Arms

- 22" Monitor mounted keyboard holder
- Mounts between monitor and VESA plate
- Compatible with all Lista monitor arms



Keyboard Holder for Flat Panel Monitor Arm

ARLINK 8000 /VSI-8 PART NO.	VSI-1/ NEXUS PART NO.	DESCRIPTION
4067	NX4067	Keyboard Holder-Flat Panel Arm

FLAT PANEL MONITOR ARMS (ARLINK & NEXUS) (CONT)

Full Function Dual Flat Panel Monitor Arm: Vertical and Horizontal Articulation; Post Mount

- 6 lockable positions for arm and Vesa plate
- Articulates horizontally and vertically
- Factory pre-tensioned articulated head
- Vesa 75/100 interface plate
- Supports up to 26 lbs. (12kg) per arm
- 12" height adjustment
- Maximum reach of 15.9" (404mm)
- Solid 1.5" diameter 15.75" high aluminum post
- Mounts through worksurface, hole diameter 1/2"

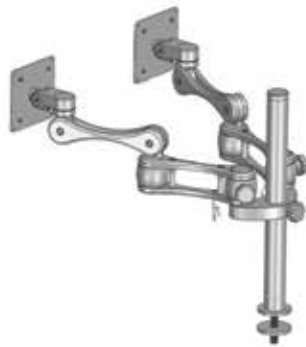

Full Function Dual Flat Panel Monitor Arm

ARLINK 8000 /VSI-8 PART NO.	VSI-1/ NEXUS PART NO.	DESCRIPTION	WEIGHT
4059	NX4059	Full Function Dual Flat Panel Monitor Arm, Post Mount	16 lbs.

FLAT PANEL MONITOR ARM ADDITIONAL OPTIONS

Full Function Extended Flat Panel Monitor Arm: Vertical and Horizontal Articulation; Column Mount, with 9 1/4" Extension

- 6 lockable positions for arm and Vesa plate
- Articulates horizontally and vertically
- Factory pre-tensioned articulated head
- Vesa 75/100 interface plate
- Supports up to 22 lbs. (10kg)
- 12" height adjustment
- Maximum reach of 25" (635mm)
- Mounts to Arlink 8000 /VSI-8 and VSI-1/ Nexus uprights



Full Function Extended Flat Panel Monitor Arm

ARLINK 8000 /VSI-8 PART NO.	VSI-1/ NEXUS PART NO.	DESCRIPTION	WEIGHT
4063	NX4063	Full Function Extended Flat Panel Monitor Arm, Col. Mount	10 lbs.

Mounting Rails (1 Knuckle) and Mounting Knuckles for Rails

- Allows multiple monitors on multiple levels
- Clamp mount knuckle can be positioned to any horizontal position.
- 5" knuckles allow tilt and angle adjustment
- Vesa 75/100 interface plate
- Rail locks into Arlink 8000 and Nexus micro slots
- Each rail includes 1 monitor mounting knuckle. Specify additional knuckles as required. Monitor size will dictate number of monitors that can be accommodated per rail.
- Some assembly required
- Mounts to Arlink 8000 /VSI-8 and VSI-1/ Nexus uprights

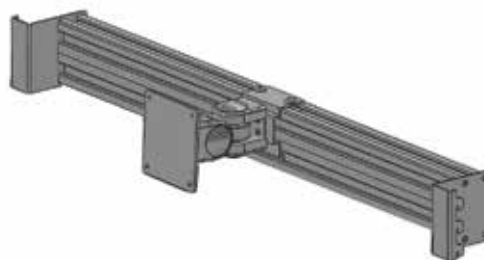

Mounting Rails (1 Knuckle)

ARLINK 8000 /VSI-8 PART NO.	VSI-1/ NEXUS PART NO.	DESCRIPTION	WEIGHT
4069	NX4069	24" Rail with 1 Knuckle	12 lbs.
4070	NX4070	30" Rail with 1 Knuckle	12 lbs.
4071	NX4071	36" Rail with 1 Knuckle	13 lbs.
4076	NX4076	42" Rail with 1 Knuckle	13 lbs.
4072	NX4072	48" Rail with 1 Knuckle	15 lbs.
4073	NX4073	60" Rail with 1 Knuckle	17 lbs.
4074	NX4074	72" Rail with 1 Knuckle	19 lbs.
4075	NX4075	Monitor Knuckle for Rail	2 lbs.

ALIGN® ADJUSTABLE HEIGHT WORKSTATIONS

Align Adjustable Height Workstations bring the user a tremendous level of ergonomic comfort, flexible functionality and enhanced productivity.

With an adjustable height ranging from 27" to 42" (not including worksurface), this workspace solution is designed with the operator in mind. It reduces fatigue, stress and potential injury. The workstation is ideally suited for repairing, testing, and assembling mechanical and electronic products and components.

Innovative features include:

- Proven, tested technology with thousands of units in use in the field
- Universal platform, which can be adjusted via motor, hand crank or manually adjusted without a lift mechanism (slide leg base)
- Center- and rear-justified options available
- Precision drive system for maintenance-free reliability
- Built-in cable/hose management duct and modesty panel
- Available for 30", 48", 60", 72" and 90" length worksurfaces, and 24", 30", 36" and 48" depth worksurfaces
- Load capacity 1000 lbs. dynamic for motorized base and 500 lbs. dynamic for hand crank base



"Aesthetics and flexibility were two key traits that swayed the decision toward the Align workstations. They are much more customizable than competitive solutions. We wanted a long-term solution, not a quick fix, and the Align bench can grow with us."

- Irene Lemay,
Team Facilitator
Cirtronics Corp.

ALIGN® WORKBENCHES: ERGONOMIC. CUSTOMIZABLE. MULTI-USER FRIENDLY.

Versatile Align workstations are ideally suited for environments where multiple users utilize the same workspace. Designed with the operator in mind, they easily adjust in height to align to individual user comfort and changing tasks. This “comfort customization” helps reduce fatigue, stress, and injury potential and increase productivity by providing each user with tailored ergonomic support and flexible functionality.

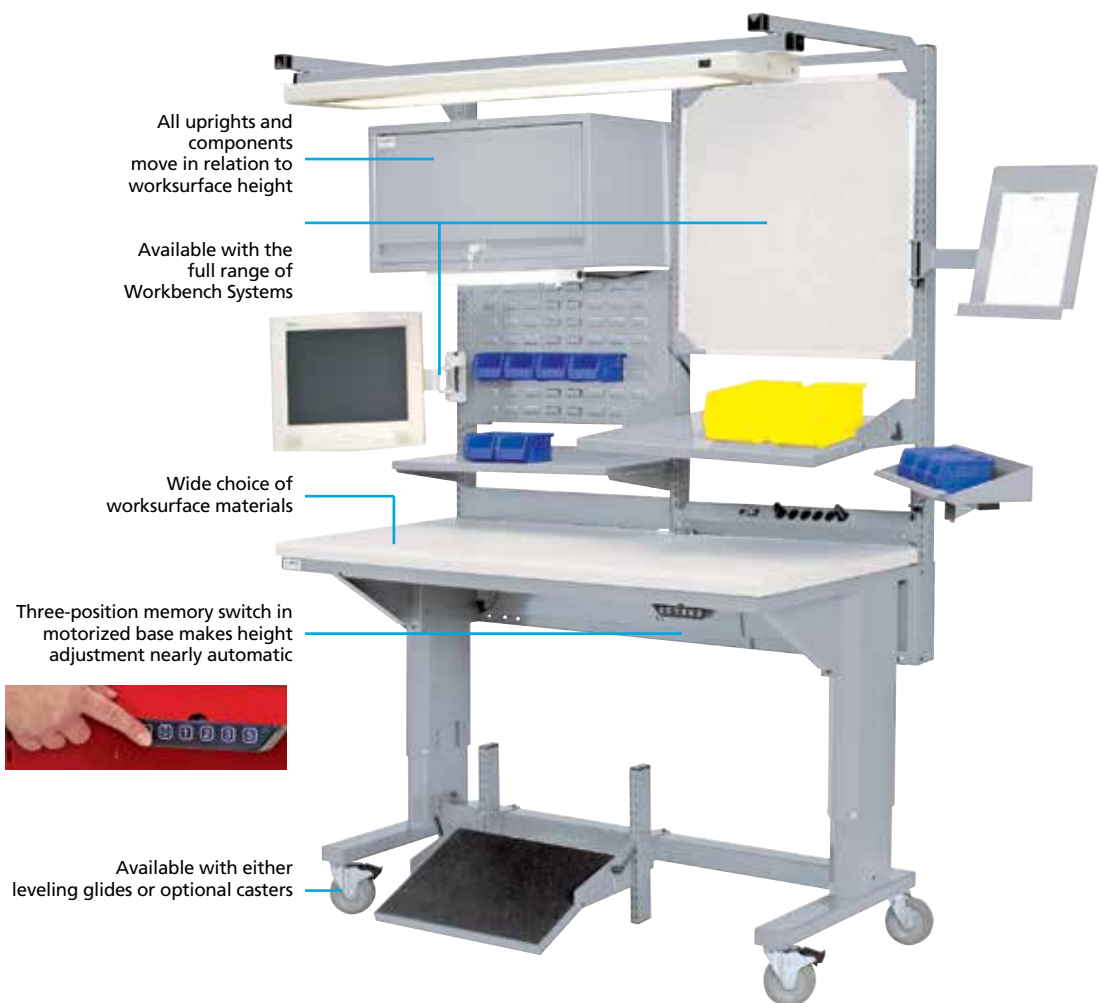





ALIGN® ADJUSTABLE HEIGHT WORKSTATIONS

Model ALE/R workstations include an Align rear-justified motorized base.
 Model ALC/R workstations include an Align rear-justified crank base.
 See page 45 for hanging cabinet descriptions.

How to order an Easy-Order Align Adjustable Height Workstation

1. Select Easy-Order workstation configuration.

2. Select worksurface style.
 See page 42 for worksurface descriptions.

PLB = Plastic laminate
 BTB = Butcher block
 SDB = Static dissipative (includes ground cord and hardware)

All worksurfaces have a bullnose front edge and are 30" deep.

3. Select worksurface size.

6030 = 60" long x 30" deep
 7230 = 72" long x 30" deep

4. Select paint color.
 Add 2-letter paint code shown in color chart on inside back cover.

5. Select lock type for models with hanging cabinet.

RG = individual
 KA = keyed-alike
 MA = master
 KP = Keypad

EXAMPLE: to order an ALE/R5201 workstation with a 72" long plastic laminate worksurface and shelf and Classic Blue paint, with an individual lock for the hanging cabinet, the part number would be **ALE/R5201-PLB7230CB**, with a **WBHC450-2-RG** hanging cabinet.

Workstations with Adjustable Riser Shelf

- Includes:
- Worksurface back stop
 - Adjustable riser shelf with back stop

Workstations with Instrument Riser Shelf

- Includes:
- (2) 16" instrument riser supports (1 with power)
 - 12" deep instrument riser shelf
 - Worksurface and shelf back stops



PART NO.	DESCRIPTION
ALE/R5000- ■ ■ <input type="checkbox"/>	motorized
ALC/R5000- ■ ■ <input type="checkbox"/>	hand crank



PART NO.	DESCRIPTION
ALE/R5001- ■ ■ <input type="checkbox"/>	motorized
ALC/R5001- ■ ■ <input type="checkbox"/>	hand crank



PART NO.	DESCRIPTION
ALE/R5002- ■ ■ <input type="checkbox"/>	motorized
ALC/R5002- ■ ■ <input type="checkbox"/>	hand crank



PART NO.	INCLUDES
ALE/R5100- ■ ■ <input type="checkbox"/>	WBHC150-1-hanging cabinet
ALC/R5100- ■ ■ <input type="checkbox"/>	WBHC150-1-hanging cabinet



PART NO.	INCLUDES
ALE/R5101- ■ ■ <input type="checkbox"/>	WBHC150-1-hanging cabinet
ALC/R5101- ■ ■ <input type="checkbox"/>	WBHC150-1-hanging cabinet

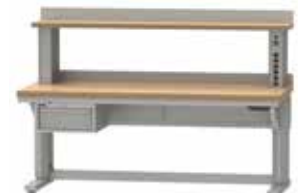

PART NO.	INCLUDES
ALE/R5102- ■ ■ <input type="checkbox"/>	WBHC150-1-hanging cabinet
ALC/R5102- ■ ■ <input type="checkbox"/>	WBHC150-1-hanging cabinet



PART NO.	INCLUDES
ALE/R5200- ■ ■ <input type="checkbox"/>	WBHC450-2-hanging cabinet
ALC/R5200- ■ ■ <input type="checkbox"/>	WBHC450-2-hanging cabinet



PART NO.	INCLUDES
ALE/R5201- ■ ■ <input type="checkbox"/>	WBHC450-2-hanging cabinet
ALC/R5201- ■ ■ <input type="checkbox"/>	WBHC450-2-hanging cabinet



PART NO.	INCLUDES
ALE/R5202- ■ ■ <input type="checkbox"/>	WBHC450-2-hanging cabinet
ALC/R5202- ■ ■ <input type="checkbox"/>	WBHC450-2-hanging cabinet

ALIGN WORKBENCH WORKSURFACES

Lista worksurfaces are all easy to maintain, rugged, and durable.

Worksurfaces come in 30", 60", 72", and 90" lengths, and are 24", 30", 36" or 48" deep, depending on worksurface. Other sizes are available, and certain worksurfaces are available with a bullnose front edge.

Butcher Block Worksurface-Sq Edge (BB), Bullnose (BN)

- Satin finish 1 3/4" thick hardwood
- Available in standard square edge or bullnose front edge



Lista Top (LT)

- 1 3/4" thick worksurface with wood core and 3/8" sanded, oil resistant pressed wood, top and bottom



Static Dissipative Plastic Laminate

Particle board core with plastic laminated top and sides, 1 9/16" thick. Grounding bolt and 10' grounding cord with a 1 megohm resistor included (installation required). Standard color is dove gray but other colors available on request. Available in standard square edge or bullnose front edge (shown above). To order a bullnose edge, add "BN" to end of part number.

Worksurfaces display electrical properties within static dissipative boundaries of 10⁶-10⁹ ohms over a wide range of relative humidities (ranging from 60% RH to as low as 10% RH) to meet ESD specifications. Meets EOS/ESD S4.1 specifications. For detailed specifications, please contact Lista.



PART NO.	LENGTH
36" deep	
SDTOP-3036	30"
SDTOP-4836	48"
SDTOP-6036	60"
SDTOP-7236	72"
SDTOP-9036	90"
48" deep	
SDTOP-60X48	60"
SDTOP-72X48	72"
SDTOP-90X48	90"

Butcher Block

PART NO.	LENGTH
24" deep	
BTOP-3024	30"
BTOP-4824	48"
BTOP-6024	60"
BTOP-7224	72"
BTOP-9024	90"

30" deep

BTOP-30	30"
BTOP-48	48"
BTOP-60	60"
BTOP-72	72"
BTOP-90	90"

36" deep

BTOP-3036	30"
BTOP-4836	48"
BTOP-6036	60"
BTOP-7236	72"
BTOP-9036	90"

48" deep

BTOP-60X48	60"
BTOP-72X48	72"
BTOP-90X48	90"

Lista Top (LT)

PART NO.	LENGTH
30" deep	
LTOP-30	30"
LTOP-48	48"
LTOP-60	60"
LTOP-72	72"
LTOP-90*	90"

36" deep

LTOP-3036	30"
LTOP-4836	48"
LTOP-6036	60"
LTOP-7236	72"
LTOP-9036	90"

Static Dissipative

Plastic Laminate

PART NO.	LENGTH
24" deep	
SDTOP-3024	30"
SDTOP-4824	48"
SDTOP-6024	60"
SDTOP-7224	72"
SDTOP-9024	90"

30" deep

SDTOP-30	30"
SDTOP-48	48"
SDTOP-60	60"
SDTOP-72	72"
SDTOP-90	90"

ALIGN WORKBENCH WORKSURFACES

Galvanized Steel Over Wood

Lista Top with additional heavy-gauge galvanized steel cover that is fitted over top and sides of Lista Top, 1 13/16" thick.



Galvanized Steel Over Wood

PART NO.	LENGTH
30" deep	
LSTOP-30	30"
LSTOP-48	48"
LSTOP-60	60"
LSTOP-72	72"
LSTOP-90	90"

36" deep

LSTOP-3036	30"
LSTOP-4836	48"
LSTOP-6036	60"
LSTOP-7236	72"
LSTOP-9036	90"

Stainless Steel Over Wood

Worksurface is constructed of durable, heavy gauge stainless steel, fitted over top and sides of partial board, 1 13/16" thick.



Stainless Steel Over Wood

PART NO.	LENGTH
30" deep	
LSSTOP-30	30"
LSSTOP-48	48"
LSSTOP-60	60"
LSSTOP-72	72"
LSSTOP-90	90"

36" deep

LSSTOP-30X36	30"
LSSTOP-48X36	48"
LSSTOP-60X36	60"
LSSTOP-72X36	72"
LSSTOP-90X36	90"

Plastic Laminate

Particle board core with plastic laminated top and sides. 1 9/16" thick. Dove gray is standard but other colors are available on request. Available in standard square edge or bullnose front edge. To order a bullnose edge, add "BN" to the end of the part number.



Plastic Laminate

PART NO.	LENGTH
24" deep	
PTOP-3024	30"
PTOP-4824	48"
PTOP-6024	60"
PTOP-7224	72"
PTOP-9024	90"

30" deep

PTOP-30	30"
PTOP-48	48"
PTOP-60	60"
PTOP-72	72"
PTOP-90	90"

36" deep

PTOP-3036	30"
PTOP-4836	48"
PTOP-6036	60"
PTOP-7236	72"
PTOP-9036	90"

48" deep

PTOP-60X48	60"
PTOP-72X48	72"
PTOP-90X48	90"

ALIGN® ADJUSTABLE HEIGHT WORKSTATION OPERATOR-ADJUSTABLE BASES

Motorized Bases

- Features a low-EMS, low-voltage dual actuator controller for synchronized leg movement and stress-free operation
- Three height positions can be preset with the programmable switch
- Static and dynamic load capacity is 1,000 lbs.
- Height range (floor to top of base, not including worksurface) is 27"-42"
- Worksurface not included – see page 42 for worksurface choices
- Some assembly required



Motorized Base rear-justified with optional casters

Motorized Bases, Rear-Justified

PART NO.	BASE WIDTH	WORKSURFACE LENGTH (MIN.)
24" deep		
ALE/R3024	29"	30"
ALE/R4824	47"	48"
ALE/R6024	59"	60"
ALE/R7224	71"	72"
ALE/R9024	89"	90"
30" deep		
ALE/R3030	29"	30"
ALE/R4830	47"	48"
ALE/R6030	59"	60"
ALE/R7230	71"	72"
ALE/R9030	89"	90"
36" deep		
ALE/R3036	29"	30"
ALE/R4836	47"	48"
ALE/R6036	59"	60"
ALE/R7236	71"	72"
ALE/R9036	89"	90"

Motorized Bases, Center-Justified

PART NO.	BASE WIDTH	WORKSURFACE LENGTH (MIN.)
30" deep		
ALE/C3030	29"	30"
ALE/C4830	47"	48"
ALE/C6030	59"	60"
ALE/C7230	71"	72"
ALE/C9030	89"	90"
36" deep		
ALE/C3036	29"	30"
ALE/C4836	47"	48"
ALE/C6036	59"	60"
ALE/C7236	71"	72"
ALE/C9036	89"	90"
48" deep		
ALE/C6048	59"	60"
ALE/C7248	71"	72"
ALE/C9048	89"	90"

Hand Crank Bases

- Hand crank static load capacity is 1,000 lbs., dynamic load capacity is 500 lbs.
- Height range (floor to top of base, not including worksurface) is 27"-42"
- Worksurface not included – see page 42 for worksurface choices
- Some assembly required



Hand crank Base center-justified

Hand Crank Bases, Rear-Justified

PART NO.	BASE WIDTH	WORKSURFACE LENGTH (MIN.)
24" deep		
ALC/R3024	29"	30"
ALC/R4824	47"	48"
ALC/R6024	59"	60"
ALC/R7224	71"	72"
ALC/R9024	89"	90"
30" deep		
ALC/R3030	29"	30"
ALC/R4830	47"	48"
ALC/R6030	59"	60"
ALC/R7230	71"	72"
ALC/R9030	89"	90"
36" deep		
ALC/R3036	29"	30"
ALC/R4836	47"	48"
ALC/R6036	59"	60"
ALC/R7236	71"	72"
ALC/R9036	89"	90"

Hand Crank Bases, Center-Justified

PART NO.	BASE WIDTH	WORKSURFACE LENGTH (MIN.)
30" deep		
ALC/C3030	29"	30"
ALC/C4830	47"	48"
ALC/C6030	59"	60"
ALC/C7230	71"	72"
ALC/C9030	89"	90"
36" deep		
ALC/C3036	29"	30"
ALC/C4836	47"	48"
ALC/C6036	59"	60"
ALC/C7236	71"	72"
ALC/C9036	89"	90"
48" deep		
ALC/C6048	59"	60"
ALC/C7248	71"	72"
ALC/C9048	89"	90"

ALIGN® ADJUSTABLE HEIGHT WORKSTATION ACCESSORIES

Casters

- Casters can be added to any adjustable height base to allow mobility
- Caster is 5" diameter, increases overall height 6". 325 lb. capacity per caster



Casters

PART NO.	DESCRIPTION
AL/CAST5X1	5" caster set, (2) swivel, (2) swivel-with-wheel-lock
CAST5X1S-NB	(1) swivel 5" caster
CAST5X1S-WB	(1) swivel-with-wheel-lock 5" caster

Offset Caster Assembly

- Offset caster assemblies do not increase the overall height range of the base
- Welded frame replaces standard feet
- Includes pair of offset frames with (2) 5" swivel casters and (2) 5" swivel-with-wheel-lock casters
- Rear casters extend 4" beyond back of worksurface
- Painted to match base
- For motorized and hand crank bases only



Offset Caster Assembly

PART NO.	DESCRIPTION
AL/CAST5X1-OF	pair of frames

Workstation Hanging Cabinets

- 16 3/4" (426mm) wide x 19 1/4" (491mm) deep
- Cabinet is suspended from the worksurface
- 50 lb. (22.5kg) weight capacity per drawer
- Usable inside dimensions: 13 1/4" (338.5mm) wide x 16 1/8" (430mm) deep
- Drawers do not accept Lista partitions and dividers
- Not available for center-justified or 24" deep rear-justified Align workstations. Cabinet can not be positioned at same end of bench as keypad or hand crank.
- Comes with individual lock and 2 keys



Figure 1

Figure 2

Figure 3

Figure 4



Figure 5

Figure 6

Figure 7

Figure 8



Figure 9

Figure 10

Figure 11

Figure 12

How to order a hanging cabinet

1. Select cabinet.

2. Select lock type.*

NL = none

KA = keyed-alike

RG = individual

MA = master

KP = keypad

3. Select paint color.

For color chart, see inside back cover.

*units ordered without lock can not have lock installed at a later date

FOR USE WITH THESE BENCHES

FIGURE	ALIGN	INDUSTRIAL & TECHNICAL	CABINET HEIGHT	DRAWER 1	DRAWER 2	DRAWER 3	DRAWER 4
1	WBHC075-1-AL	WBHC075-1-WB	5.20"	2-3/4"			
2	WBHC150-1-AL	WBHC150-1-WB	8.15"	5-3/4"			
3	WBHC150-2-AL	WBHC150-2-WB	8.15"	2-3/4"	2-3/4"		
4	WBHC300-1-AL	WBHC300-1-WB	14.06"	12" File			
5	WBHC300-2-AL	WBHC300-2-WB	14.06"	5-3/4"	5-3/4"		
6	WBHC300-3-AL	WBHC300-3-WB	14.06"	2-3/4"	2-3/4"	5-3/4"	
7	WBHC300-4-AL	WBHC300-4-WB	14.06"	2-3/4"	2-3/4"	2-3/4"	2-3/4"
8	WBHC450-1FD-AL	WBHC450-1FD-WB	19.96"	5-3/4"	Door		
9	WBHC450-2-AL	WBHC450-2-WB	19.96"	5-3/4"	12" File		
10	WBHC450-3-AL	WBHC450-3-WB	19.96"	5-3/4"	5-3/4"	5-3/4"	
11	WBHC450-31-AL	WBHC450-31-WB	19.96"	2-3/4"	2-3/4"	12" File	
12	WBHC450-4-AL	WBHC450-4-WB	19.96"	2-3/4"	2-3/4"	5-3/4"	5-3/4"

DRAWER USABLE HEIGHTS

DRAWER PULL OPTIONS

DESCRIPTION
Hanging Cabinet Tech Drawer Pull (Chrome Color)
Hanging Cabinet Tech Drawer Pull (Brushed Silver)
Hanging Cabinet Tech Drawer Pull (Gloss Black)

ALIGN & INDUSTRIAL UPGRADE

HNDL-NSNW/CHRM
HNDL-NSNW/BRSH
HNDL-NSNW/GBLK

ALIGN® ADJUSTABLE HEIGHT WORKSTATION ACCESSORIES

Align Bottom Shelves

- Provides open storage beneath worksurface
- 16" deep
- Accepts vertical wire dividers (see below)
- 150 lb. (68kg) capacity
- For motorized and hand crank bases only



Vertical Wire Dividers for Bottom Shelves

- 15" deep dividers are 1/4" diameter galvanized wire that fit into pre-punched holes in the 16" deep shelf
- No hardware required



CPU Holder

- Mounts to underside of worksurface
- 9 1/2" wide x 18" deep x 20" high
- Painted to match workstation



Adjustable CPU Holder

- Adjustable pullout CPU holder has 360° rotation
- Accommodates CPU width range of 2"-8 1/2" and CPU height range of 11"-22"
- Mounts to worksurface support beams



Keyboard Holder

- Tiltable keyboard holder allows computer keyboard to be stored under worksurface when not in use
- Includes swivel pull-out mouse pad which can be attached to either right or left side

Align Attached Footrest

- Ergonomic footrest attaches over Align base stringer
- Height adjustable from 3"-12 1/4" (plus height of stringer)
- Footrest platform is 15" deep x 21 3/4" wide, and adjusts from totally flat to a 25° angle
- Ribbed mat included
- Not compatible with 30" wide Align workstations



Freestanding Footrest

- Ergonomic footrest provides support for user's feet
- Height adjustable from 3"-12 1/4"
- Footrest platform is 15" deep x 21 3/4" wide, and adjusts from totally flat to a 25° angle
- Ribbed mat included



Bottom Shelves

PART NO.	LENGTH
ALBS/F-4816	48"
ALBS/F-6016	60"
ALBS/F-7216	72"
ALBS/F-9016	90"

Wire Dividers

PART NO.	HEIGHT
NXS/WD150-15	6"
NXS/WD250-15	10"
NXS/WD450-15	18"

CPU Holder

PART NO.
CPU/H

Adjustable CPU

Holder
PART NO.
CPU/H-ADJ/SOR

Keyboard Holder

PART NO.	L X W
WB/KBH	21" x 10"

Attached Footrest

PART NO.
AL/AFR

Freestanding Footrest

PART NO.
WB/FFR

ALIGN® ADJUSTABLE HEIGHT WORKSTATION ACCESSORIES

Nexus Rear-Mount Frames

- For use with Align® rear-justified adjustable height bases only
- Starter frames consist of 2 upright posts, a horizontal rail, brackets and hardware
- Adder sets consist of an additional upright, a horizontal rail and a bracket
- Frames are sturdy, heavy gauge steel, and are notched front and back at 1" increments for mounting accessories
- Uprights are available in heights of 30" and 48" (height = usable height above top of base), and widths of 24", 30", 36", 42", 48" and 60"
- Specify color from chart on the inside back cover
- Must be inset 3" to center of upright. For wider applications see Nexus Extender Rear mount frames below



30" High* Rear-Mount Frames

PART NO.	SEC. WIDTH CENT.-TO-CENT.
Starter set	
NXF/RM2430	24"
NXF/RM3030	30"
NXF/RM3630	36"
NXF/RM4230	42"
NXF/RM4830	48"
NXF/RM6030	60"
Adder set	
NXF/RM2430A	24"
NXF/RM3030A	30"
NXF/RM3630A	36"
NXF/RM4230A	42"
NXF/RM4830A	48"
NXF/RM6030A	60"

* upright overall height is 48"

48" High* Rear-Mount Frames

PART NO.	SEC. WIDTH CENT.-TO-CENT.
Starter set	
NXF/RM2448	24"
NXF/RM3048	30"
NXF/RM3648	36"
NXF/RM4248	42"
NXF/RM4848	48"
NXF/RM6048	60"
Adder set	
NXF/RM2448A	24"
NXF/RM3048A	30"
NXF/RM3648A	36"
NXF/RM4248A	42"
NXF/RM4848A	48"
NXF/RM6048A	60"

* upright overall height is 60"

Nexus Extended Rear-Mount Frames

- For use with Align® rear-justified adjustable height bases only
- Allows use of the full width of an Align rear-justified adjustable height workstation for support of a Nexus system
- The total width of the extended rear-mount frame must equal the width of the Align workstation
- Extended rear-mount frame is the starter set; use the standard rear-mount adder for adder unit
- Not for use with Align workstations that are placed flush side-to-side
- Specify color from chart on back cover
- Extends approximately ¾" beyond end of work surface at each end



30" High* Extended Rear-Mount Frames

PART NO.	WIDTH
NXF/RM2430-EXT	24"
NXF/RM3030-EXT	30"
NXF/RM3630-EXT	36"
NXF/RM4230-EXT	42"
NXF/RM4830-EXT	48"
NXF/RM6030-EXT	60"

* upright overall height is 48"

48" High* Extended Rear-Mount Frames

PART NO.	WIDTH
NXF/RM2448-EXT	24"
NXF/RM3048-EXT	30"
NXF/RM3648-EXT	36"
NXF/RM4248-EXT	42"
NXF/RM4848-EXT	48"
NXF/RM6048-EXT	60"

* upright overall height is 60"

MOBILE CABINETS: SECURE. DURABLE. ORGANIZED.

Lista mobile cabinets are the ideal complement to your Arlink or Align workbench, creating flexible, heavy-duty tool storage right beneath your workbench. Mobile cabinets bring accessible, secure personal storage within arm's reach and are perfectly sized to fit below your Arlink and Align workstations. When you need to take your work on the go, mobile cabinets move with you, letting you work anywhere with ease and convenience.

Features:

- Your choice of durable worksurface materials to suit your specific application
- Full-extension, 440 lb. capacity drawers with individual drawer latches (IDL) keep drawers safely secured when mobile
- Sub-dividable drawers let you create compartments around your specific storage needs
- Your choice of sturdy handles mounted directly to cabinet housing for easy maneuverability
- Two swivel and two fixed heavy-duty casters with pedal wheel locks for safe, controlled mobility
- Includes PrevenTip® interlock system, which helps prevent tipping by allowing only one drawer to be extended at a time
- Cylinder lock and 2 keys



How to order a mobile companion cabinet

1. Select cabinet.
2. Select lock type.

NL = none
KA = keyed-alike
RG = individual
MA = master
KP = keypad

3. Select paint color.
 For color chart, see p.57.



Drawer Handle Pulls (Optional)

For those not requiring labeling of drawers or contents aluminum extruded covers are available in three finishes including: gloss black, chrome color, and brushed silver.

UPGRADE PART NUMBERS (REPLACES SCRIPT HANDLE COVER)

COLORS STYLE WIDTH	BRUSHED SILVER PART NO.	CHROME COLOR PART NO.	GLOSS BLACK PART NO.
NS/NW	HNDL-NSNW/BRSH	HNDL-NSNW/CHRM	HNDL-NSNW/GBLK
CL/MP	HNDL-CLMP/BRSH	HNDL-CLMP/CHRM	HNDL-CLMP/GBLK
ST/SC	HNDL-STSC/BRSH	HNDL-STSC/CHRM	HNDL-STSC/GBLK
ES/EW	HNDL-ESEW/BRSH	HNDL-ESEW/CHRM	HNDL-ESEW/GBLK
HS/HW	HNDL-HSHW/BRSH	HNDL-HSHW/CHRM	HNDL-HSHW/GBLK
ML/MI	HNDL-MLMI/BRSH	HNDL-MLMI/CHRM	HNDL-MLMI/GBLK
MS/MW	HNDL-MSMW/BRSH	HNDL-MSMW/CHRM	HNDL-MSMW/GBLK
HT/DW	HNDL-HTDW/BRSH	HNDL-HTDW/CHRM	HNDL-HTDW/GBLK

CL MOBILE COMPANION CABINETS

A cost-competitive, space-efficient and highly maneuverable mobile cabinet. Full extension drawers with a weight capacity of 440 lbs. (200kg). All Models listed here contain pre-configured drawer interior sets. TCN tray behind doors are full Extension and have a weight capacity of 165 lbs. (75kg).

450 MOBILE COMPANION CABINETS

Cabinet Overall Dimensions (including casters), 22.2"W x 22.52"D x 26.85"H

To complete part number, specify lock option and paint color .



CL0450-0201FB-M



CL0450-0204FB-M



CL0450-0205FB-M



CL0450-0306FB-M



CL0450-0401FB-M



CL0450-0405FB-M

USABLE DRAWER HEIGHTS

SEE PAGE 51 FOR DRAWER INTERIOR DETAILS

PART NO.	DRAWER 1	DRAWER 2	DRAWER 3	DRAWER 4	INTERIOR 1	INTERIOR 2	INTERIOR 3	INTERIOR 4	COMPARTMENTS
CL0450-0201FB-M- <input type="checkbox"/>	5.12"	11.02	-	-	CLDR206-150	CLDR104-300	-	-	10
CL0450-0204FB-M- <input type="checkbox"/>	5.12"	TCN w/Door	-	-	CLDR206-150	-	-	-	6
CL0450-0205FB-M- <input type="checkbox"/>	5.12"	TCN w/Door	-	-	CLDR206-150	-	-	-	6
CL0450-0306FB-M- <input type="checkbox"/>	5.12"	5.12"	5.12"	-	CLDR209-150	CLDR209-150	CLDR104-150	-	22
CL0450-0401FB-M- <input type="checkbox"/>	2.17"	2.17"	3.15"	7.09"	CLDR312-075	CLDR312-075	CLDR209-100	CLDR104-200	37
CL0450-0405FB-M- <input type="checkbox"/>	2.17"	4.13"	4.13"	4.13"	CLDR312-075	CLDR209-100	CLDR209-100	CLDR206-100	36

*All drawers are full extension, 440 lb. capacity, with 18" wide x 18" deep usable inside drawer dimensions. TCN's have 165 lb. capacity, with 16.7" wide x 18" deep usable inside dimensions.

600 MOBILE COMPANION CABINETS

Cabinet Overall Dimensions (including casters), 22.2"W x 22.52"D x 32.76"H

To complete part number, specify lock option and paint color .

See page 48 for drawer handle pull upgrade.



CL0600-0206FB-M



CL0600-0207FB-M



CL0600-0301FB-M



CL0600-0303FB-M



CL0600-0404FB-M



CL0600-0701FB-M

USABLE DRAWER HEIGHTS

PART NO.	DRAWER 1	DRAWER 2	DRAWER 3	DRAWER 4	DRAWER 5	DRAWER 6	DRAWER 7
CL0600-0206FB-M- <input type="checkbox"/>	5.12"	TCN w/Door	-	-	-	-	-
CL0600-0207FB-M- <input type="checkbox"/>	5.12"	TCN w/Door	-	-	-	-	-
CL0600-0301FB-M- <input type="checkbox"/>	5.12"	5.12"	11.02"	-	-	-	-
CL0600-0303FB-M- <input type="checkbox"/>	3.15"	7.09"	11.02"	-	-	-	-
CL0600-0404FB-M- <input type="checkbox"/>	5.12"	5.12"	5.12"	5.12"	-	-	-
CL0600-0701FB-M- <input type="checkbox"/>	2.17"	2.17"	2.17"	2.17"	3.15"	3.15"	3.15"

SEE PAGE 51 FOR DRAWER INTERIOR DETAILS

PART NO.	INTERIOR 1	INTERIOR 2	INTERIOR 3	INTERIOR 4	INTERIOR 5	INTERIOR 6	INTERIOR 7	COMPARTMENTS
CL0600-0206FB-M- <input type="checkbox"/>	CLDR206-150	-	-	-	-	-	-	6
CL0600-0207FB-M- <input type="checkbox"/>	CLDR206-150	-	-	-	-	-	-	6
CL0600-0301FB-M- <input type="checkbox"/>	CLDR206-150	CLDR206-150	CLDR104-300	-	-	-	-	16
CL0600-0303FB-M- <input type="checkbox"/>	CLDR209-100	CLDR206-200	CLDR104-300	-	-	-	-	19
CL0600-0404FB-M- <input type="checkbox"/>	CLDR209-100	CLDR209-100	CLDR104-150	CLDR104-150	-	-	-	26
CL0600-0701FB-M- <input type="checkbox"/>	CLDR312-075	CLDR312-075	CLDR312-075	CLDR312-075	CLDR209-100	CLDR209-100	CLDR209-100	75

*All drawers are full extension, 440 lb. capacity, with 18" wide x 18" deep usable inside drawer dimensions. TCN's have 165 lb. capacity, with 16.7" wide x 18" deep usable inside dimensions.

CL WIDTH PRECONFIGURED DRAWER INTERIORS FOR MOBILE CABINETS

To order the drawer interior sets shown on this page, use the part number in the chart and add the drawer height in place of the green box.

EXAMPLE: to order a CLDR104 drawer interior set for a 100 height (3") drawer, the part ordering number would be **CLDR104-100**.



For all drawer heights		
PART NO.	COMPTS.	CMPT.
WIDTH		
CLDR104- 	2	7.50"
	2	9.25"



For drawer heights 75 through 250		
PART NO.	COMPTS.	CMPT.
WIDTH		
CLDR206- 	6	5.50"



For drawer heights 75 through 250		
PART NO.	COMPTS.	CMPT. WIDTH
CLDR209- 	9	5.50"



For drawer heights 75 through 200		
PART NO.	COMPTS.	CMPT. WIDTH
CLDR312- 	3	3.50"
	9	4.125"



For drawer heights 75 through 200		
PART NO.	COMPTS.	CMPT. WIDTH
CLDR316- 	4	3.50"
	12	4.125"



For drawer heights 75 through 125		
PART NO.	COMPTS.	CMPT. WIDTH
CLDR415- 	9	2.625"
	6	3.50"



For drawer heights 75 through 125		
PART NO.	COMPTS.	CMPT. WIDTH
CLDR420- 	12	2.625"
	8	3.50"



For drawer heights 75 through 125		
PART NO.	COMPTS.	CMPT. SIZE
CLDR009- 	9	6" x 6"



For drawer heights 75 through 125		
PART NO.	COMPTS.	CMPT. SIZE
CLDR012- 	6	6" x 6"
	6	3" x 6"



For drawer heights 75 through 125		
PART NO.	COMPTS.	CMPT. SIZE
CLDR018- 	18	3" x 6"

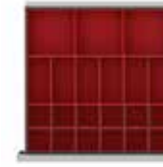

For drawer height 75		
PART NO.	COMPTS.	CMPT. SIZE
CLDR021-75	3	6" x 6"
	6	3" x 6"
	12	3" x 3"

ERGONOMIC SEATING: COMFORTABLE. DURABLE. SUPPORTIVE.

Enhance your workspace and amplify productivity with Lista's comfortable ergonomic seating. Designed to ensure proper body support and built tough for the most rugged work environments, our seating solutions keep you ergonomically-positioned for hour-after-hour support and optimum performance on the job.

When it comes to storage components Lista® packs the toughest punch money can buy. Wouldn't it be great if there was a seating line that delivered the same level of durability, whilst providing unsurpassed comfort and functionality?

Well now there is.

Lista's new industrial seating line combines the down-and-dirty ruggedness, with hour-after-hour comfort. Built tough, for performance that lasts and is ergonomically designed to ensure proper body support. Our standard offering provide the perfect complement to any existing storage system, tailoring to specific on site job tasks and environments, custom fit to your needs with a variety of available accessories.



SEATING SOLUTIONS

We've got the seating solutions to support you all day long. Built to withstand the most rugged environments, our new industrial seating line keeps your technicians ergonomically-positioned and comfortable for hour-after-hour support on the job.



Deluxe ESD Chair:

Multi-functional chair with ergonomic arm support. Includes casters and armrests.

PART NO.
CHR-WB-ESDDLX/C1



ESD Workbench Chair:

Multifunctional chair meeting most workbench heights. Includes casters.

PART NO.
CHR-WB-ESD/C1



Mid-Back Workbench Chair - Upholstered:

Heavy-duty, adjustable chair designed for multiple shifts.

ACCESSORIES	PART NO.
Casters	CHR-WB-ESDDLX/C1
Armrests & Casters	CHR-WB-MB/A/C1



Deluxe Mid-Back Workbench Chair - Upholstered:

Heavy-duty, adjustable chair designed for multiple shifts, with more maneuverability options.

ACCESSORIES	PART NO.
Casters	CHR-WB-MBDLX/C1
Armrests & Casters	CHR-WB-MBDLX/A

ADDITIONAL STORAGE & WORKSPACE SOLUTIONS

Lista offers a variety of organized, space-efficient solutions designed to help you improve productivity in your facility.

STORAGE WALL®

Lista's unique Storage Wall® System provides unparalleled storage versatility. Packed with wall-to-wall organizational features designed to optimize efficiency, the Storage Wall® System lets you conveniently and logically store different-sized items in one organized, accessible location. Available in a combination of industrial-strength shelves, drawers, roll-out trays, and tough doors, Storage Wall® Systems can be customized exactly to your unique requirements.



STAK SYSTEM®

The Stak System® makes storing and retrieving heavy, bulky items easy and efficient, while saving valuable space. Featuring adjustable pallets and a captive lifting and handling device, the Stak System® offers ultimate storage flexibility – allowing you to store more inventory and less air. Easy-to-learn and easy-to-use controls don't require license or certification like a fork lift truck. The result: less wasted space, increased item retrieval efficiency, and a safer work environment.

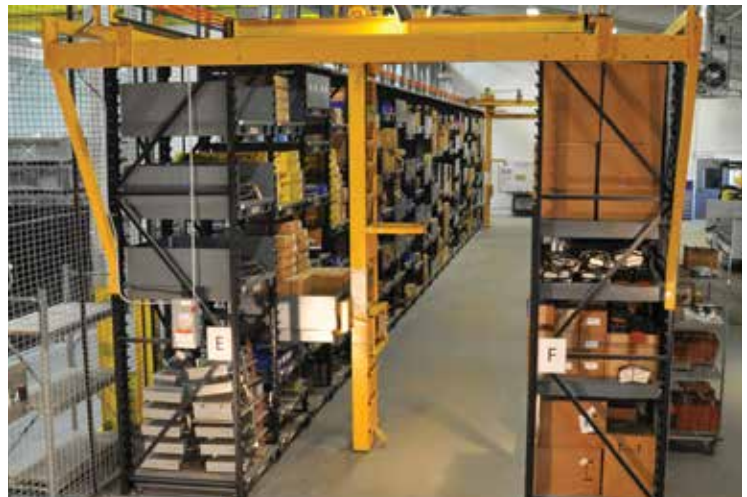

LISTA/VIDMAR STATIONARY DRAWER STORAGE CABINETS

Space is valuable. Our industrial cabinets make every square inch of your workspace work with the highest density storage and an almost infinite variety of cabinet footprints and drawer heights. Whether you're storing large or small parts, our full-height sidewalls, partitions, and dividers offer systematic organization to speed efficiency while maximizing available cubic space.



PACKING AND SHIPPING BENCHES

Our workbenches help expedite packing and shipped with a host of application-specific features. Their ergonomic design brings packing material items to arm height for easy access and support. Benches are available in a variety of lengths and depths to fit your exact needs, and come in a selection of durable worksurfaces.

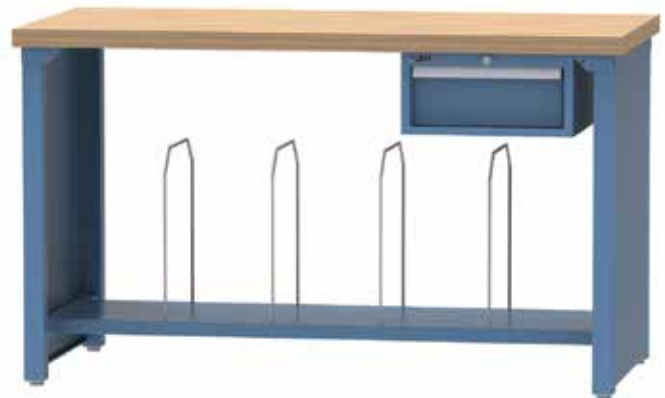

LISTAWORKS™ SURVEY & DESIGN SERVICES

Our sales and design team is ready to provide ListaWorks™ for you free of charge. First, Lista listens. Then we collaborate with you to create a detailed, customized plan for your individual furniture and storage needs; one that offers solutions that maximize efficiency and flexibility while optimizing space, durability and aesthetics.

- **Customized Surveys and Layouts** – Lista experts will survey your current and future needs, then work with you to propose solutions that provide the greatest utility and adaptability.
- **Floorspace Utilization Analysis** – We will prepare, plan and create CAD and/or photorealistic renderings for a grouping of products or an entire room-size solution.
- **Integration with Architectural and Construction Planning** – You can rely on Lista's experience in coordinating with architectural and construction professionals at every stage of your project's development.
- **Price Quotes** – We provide free estimates and price quotes, regardless of size.
- **Demo Product** – Want to test drive a product on us? Contact our sales consultants to arrange for a demo product to be shipped to your site. We know once you compare our quality to the rest, you'll be convinced Lista is the right choice.

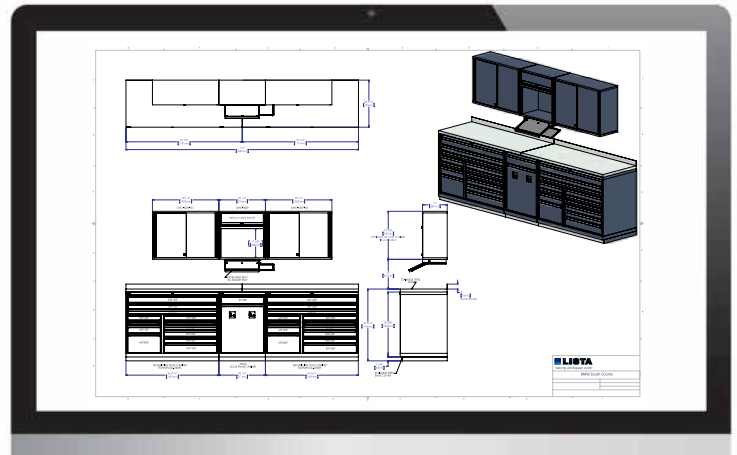

GET A LISTAWORKS™ SPACE EVALUATION

At Lista, we don't just sell products. We customize workplace solutions. The first step toward making your workspace work for you is a complimentary ListaWorks™ space evaluation. We work with you to assess your facility and then provide you with a customized plan to maximize efficiency, productivity, and space in your facility. Give us a call today to get started.

Arlink Colors

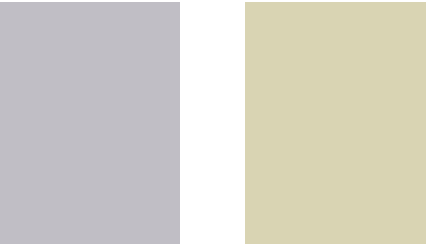

CODE	COLOR	CODE	COLOR
LG*	Light Gray	SN	Sand

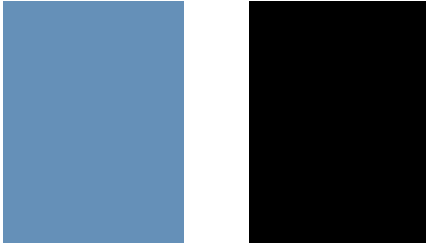

CODE	COLOR	CODE	COLOR
BB	Bright Blue	BL	Black

* Available with ESD properties. To specify ESD paint, add prefix "ESD" to paint part number. For ESD paint specifications, contact Lista Customer Service. ESD paint not available for Arlink® 8000 products.

Color differences exist between color samples and actual finishes. Please contact your Lista representative for accurate color matching. Custom colors are available and will be quoted on request.

Trim Colors

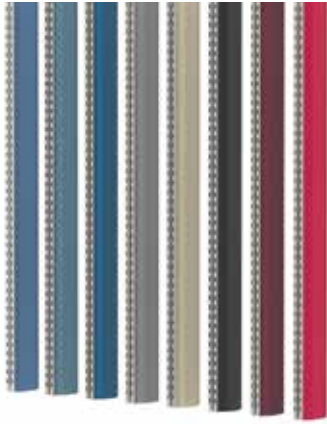

- Bright Blue (BB)
- Classic Blue (CB)
- Royal Blue (RB)
- Dark Gray (GR)
- Sand (SN)
- Black (BL)
- Burgundy (BUR)
- Red (NR)

LISTA®

Making Workspace Work.

Industrial Ergonomics

612-532-6774

jeff@Industrial-Ergonomics.com



StanleyBlack&Decker

©2017 Lista International Corp.

MKT-2758 | SWSLWBSOLCAT | REV1

InnerSpace **Vidmar**

Learn more about the other premier brands that make up the Stanley Black & Decker family of storage solutions.